

Aspire 8920 Series Service Guide

Service guide files and updates are available on the ACER/CSD web; for more information, please refer to <http://csd.acer.com.tw>

PRINTED IN TAIWAN

Revision History

Please refer to the table below for the updates made on Aspire 8920 service guide.

Date	Chapter	Updates

Copyright

Copyright © 2008 by Acer Incorporated. All rights reserved. No part of this publication may be reproduced, transmitted, transcribed, stored in a retrieval system, or translated into any language or computer language, in any form or by any means, electronic, mechanical, magnetic, optical, chemical, manual or otherwise, without the prior written permission of Acer Incorporated.

Disclaimer

The information in this guide is subject to change without notice.

Acer Incorporated makes no representations or warranties, either expressed or implied, with respect to the contents hereof and specifically disclaims any warranties of merchantability or fitness for any particular purpose. Any Acer Incorporated software described in this manual is sold or licensed "as is". Should the programs prove defective following their purchase, the buyer (and not Acer Incorporated, its distributor, or its dealer) assumes the entire cost of all necessary servicing, repair, and any incidental or consequential damages resulting from any defect in the software.

Acer is a registered trademark of Acer Corporation.

Intel is a registered trademark of Intel Corporation.

Pentium and Pentium II/III are trademarks of Intel Corporation.

Other brand and product names are trademarks and/or registered trademarks of their respective holders.

Conventions

The following conventions are used in this manual:

SCREEN MESSAGES	Denotes actual messages that appear on screen.
NOTE	Gives bits and pieces of additional information related to the current topic.
WARNING	Alerts you to any damage that might result from doing or not doing specific actions.
CAUTION	Gives precautionary measures to avoid possible hardware or software problems.
IMPORTANT	Reminds you to do specific actions relevant to the accomplishment of procedures.

Preface

Before using this information and the product it supports, please read the following general information.

1. This Service Guide provides you with all technical information relating to the BASIC CONFIGURATION decided for Acer's "global" product offering. To better fit local market requirements and enhance product competitiveness, your regional office MAY have decided to extend the functionality of a machine (e.g. add-on card, modem, or extra memory capability). These LOCALIZED FEATURES will NOT be covered in this generic service guide. In such cases, please contact your regional offices or the responsible personnel/channel to provide you with further technical details.
2. Please note WHEN ORDERING FRU PARTS, that you should check the most up-to-date information available on your regional web or channel. If, for whatever reason, a part number change is made, it will not be noted in the printed Service Guide. For ACER-AUTHORIZED SERVICE PROVIDERS, your Acer office may have a DIFFERENT part number code to those given in the FRU list of this printed Service Guide. You MUST use the list provided by your regional Acer office to order FRU parts for repair and service of customer machines.

System Specifications

Features

Below is a brief summary of the computer's many features:

Operating system

- Windows Vista™

NOTE: Windows® Vista™ Capable PCs come with Windows® XP installed, and can be upgraded to Windows® Vista™. For more information on Windows® Vista™ and how to upgrade, go to: Microsoft.com/windowsvista.

Platform and memory

Intel® Core™2 Duo mobile processor Mobile Intel® GM965 Express Chipset
Mobile Intel® GM965 Express Chipset
Intel® Wireless WiFi Link Wi-Fi CERTIFIED® network connection, or Intel® PRO/Wireless Wi-Fi CERTIFIED® network connection

System memory •

Dual-Channel DDR2 SDRAM support
Up to 2 GB of DDR2 667 MHz memory, upgradeable to 4 GB using two soDIMM modules

Display and graphics

18.4" WUXGA
NVIDIA® GeForce® 9650M GS with up to 1280 MB of TurboCache™ or NVIDIA® GeForce® 8600M GT with up to 1280 MB of TurboCache™

TV-tuner

Digital TV-tuner supporting DVB-T

Audio

Dolby® -certified surround sound system with five built-in stereo speakers and one subwoofer supporting lowfrequency effects
S/PDIF (Sony/Philips Digital Interface) support for digital speakers
Built-in stereo microphones

Storage subsystem

2.5" hard disk drive
Optical drive options:
Blu-ray Disc™ (BD) drive
DVD-Super Multi double-layer drive
6-in-1 card reader

Input devices

105-/106-key keyboard
Touchpad pointing device
Acer CineDash media console capacitive human interface device

Communication

Acer Video Conference, featuring:
Integrated Acer Crystal Eye webcam
Acer PureZone technology
Optional Acer Xpress VoIP phone

WLAN:

Intel® Wireless WiFi Link network connection or Intel® PRO/Wireless network connection

I/O Ports

ExpressCard™/54 slot
6-in-1 card reader (SD™, MMC, MMCplus™, MS, MS PRO, xD)
USB 2.0 ports
HDMI™ port with HDCP support
Consumer infrared (CIR) port
External display (VGA) port
Headphone/speaker/line-out jack with S/PDIF support
Microphone-in jack
Line-in jack
Ethernet (RJ-45) port
Modem (RJ-11) port
DC-in jack for AC adapter

Environment

Temperature:

- operating: 5° C to 35° C
- Non-operating: -20° C to 65° C

Humidity (non-condensing):

- operating: 20%~80%
- Non-operating: 20%~80%

System Block Diagram

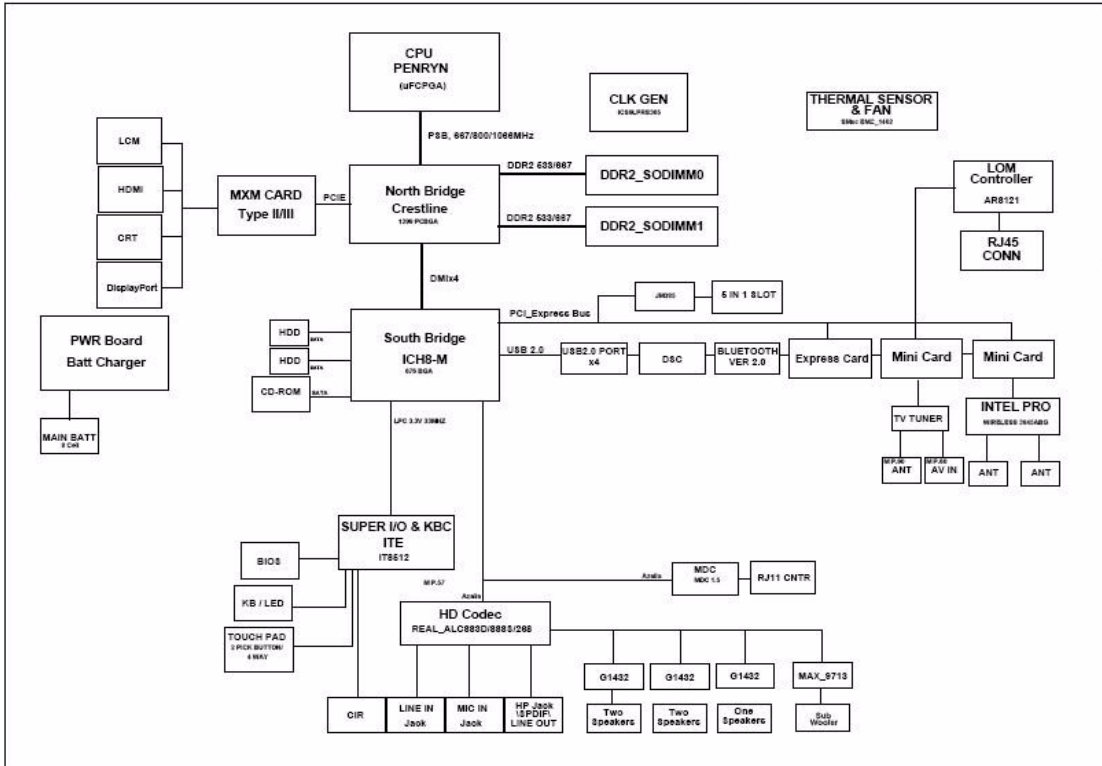

Board Layout

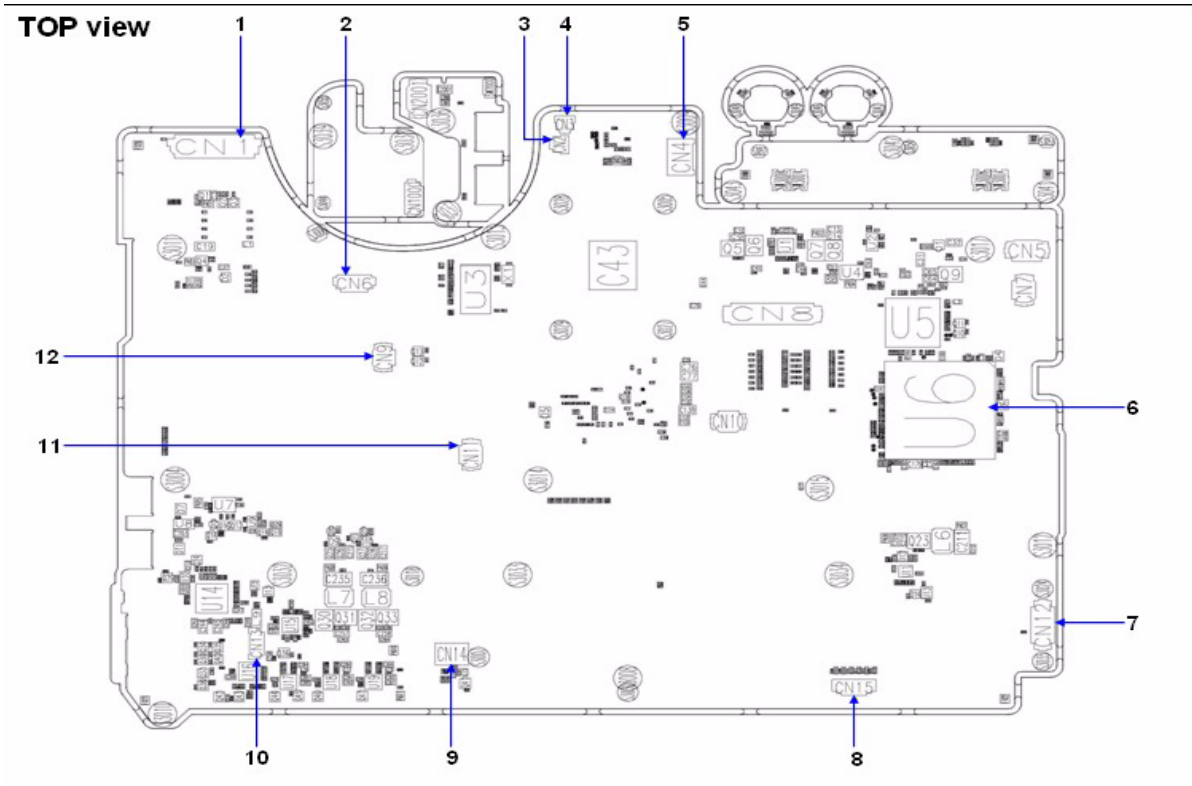

AS8920 M/B layout and connector location TOP view		
No.	Name	Description
1	CN1	LCM Cable CNTR
2	CN6	Power Board FFC CNTR
3	CN2	LED Board Cable CNTR
4	CN3	LED Board Cable CNTR
5	CN4	Power cable CNTR
6	U6	South Bridge
7	CN12	I/O Board CNTR
8	CN15	Speaker cable CNTR
9	CN14	MDC CNTR
10	CN13	BT Cable CNTR
11	CN11	Touch Pad FFC CNTR
12	CN9	Media consle Board CNTR

Bottom view

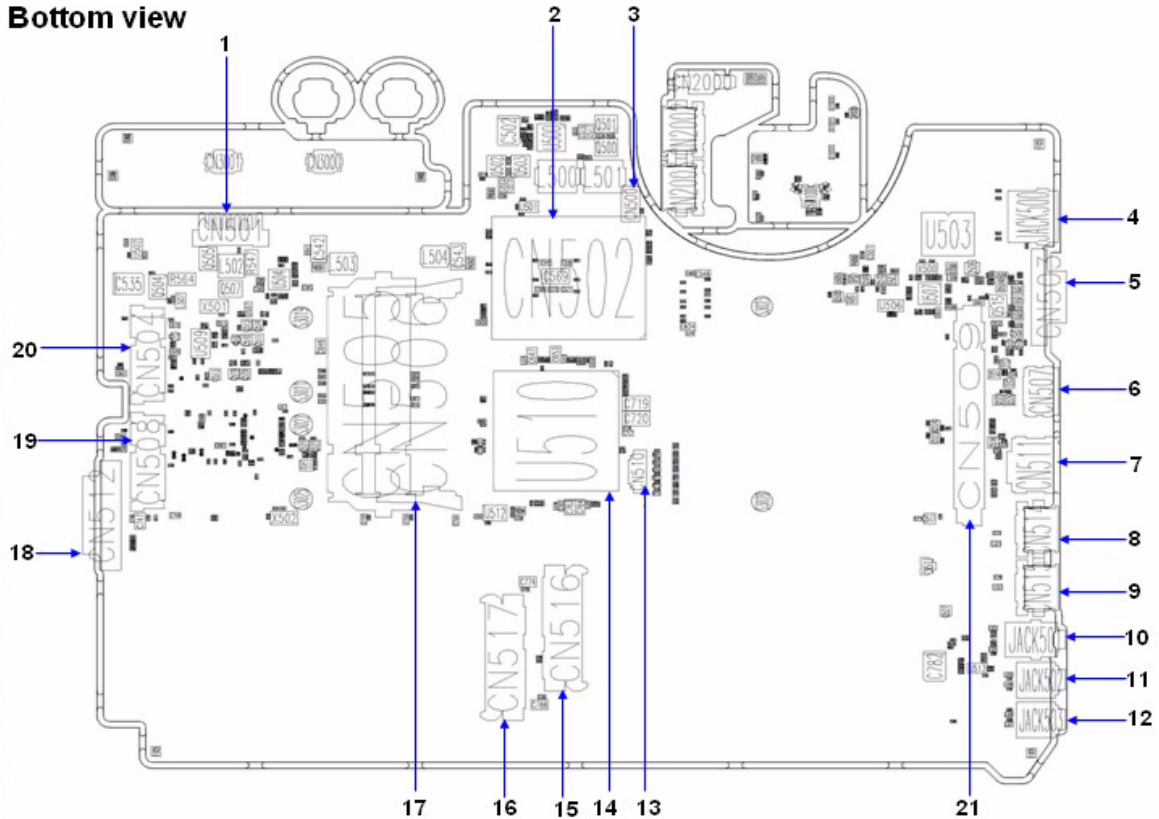

Bottom view		
No.	Name	Description
1	CN501	Battery CNTR
2	CN502	CPU Socket
3	CN500	FAN Cable CNTR
4	Jack500	RJ45
5	CN503	VGA Port
6	CN507	HDMI Port
7	CN511	HDMI Port
8	CN514	USB Port
9	CN515	USB Port
10	Jack501	SPDIF
11	Jack502	MIC jack
12	Jack503	Line in jack
13	CN510	Speaker Cable CNTR
14	U510	North Bridge
15	CN516	HDD socket
16	CN517	HDD socket
17	CN505/506	DIMM Socket
18	CN512	ODD CNTR
19	CN508	PCI-E socket
20	CN504	PCI-E socket
21	CN509	VGA Card Socket

Your Acer Notebook tour

After knowing your computer features, let us show you around your new Aspire computer.

Front View

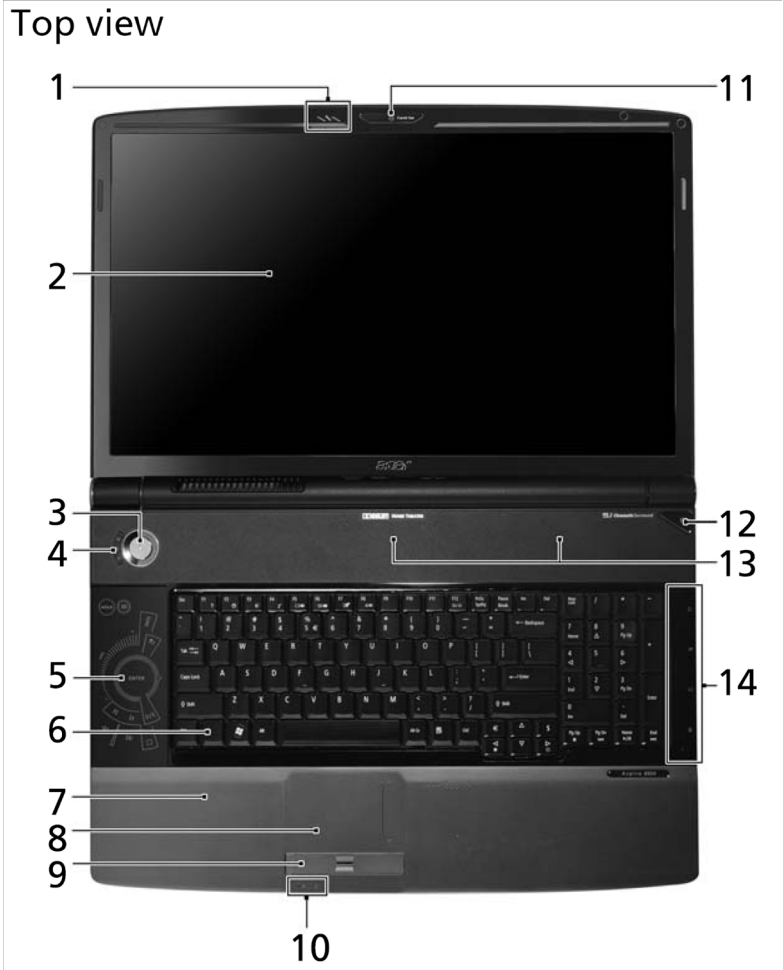

#	Item	Description
1	Acer PureZone	Two internal stereo microphones for sound recording.
2	Display screen	Also called Liquid-Crystal Display (LCD), displays computer output.
3	Power button	Turns the computer on and off.
4	Status indicators	Light-Emitting Diodes (LEDs) that light up to show the status of the computer's functions and components.
5	CineDash media console	The CineDash media console is a touch-sensitive entertainment interface
6	Keyboard	For entering data into your computer.
7	Palmrest	Comfortable support area for your hands when you use the computer.
8	Touchpad	Touch-sensitive pointing device which functions like a computer mouse.
9	Click buttons (left, center* and right)	The left and right buttons function like the left and right mouse buttons. *The center button serves as Acer Bio-Protection fingerprint reader supporting Acer FingerNav 4-way control function (for selected models).
10	Status indicators	Light-Emitting Diodes (LEDs) that light up to show the status of the computer's functions and components.
11	Acer Crystal Eye	Web camera for video communication. (for selected models)
12	Empowering key	Launch Acer Empowering Technology
13	Speakers	Left and right speakers deliver stereo audio output.
14	Easy-launch button	Buttons for launching frequently used program.



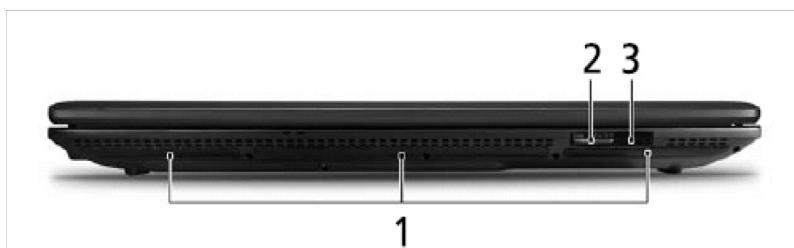





Closed Front View



#	Icon	Item	Description
1		Speakers	Left and right speakers deliver stereo audio output.
2		6-in-1 card reader	Accepts Secure Digital (SD), MultiMediaCard (MMC), MultiMediaCard Plus (MMCplus), Memory Stick (MS), Memory Stick PRO (MS PRO), xD-Picture Card (xD).
3		CIR receiver	Receives signals from a remote control.





Left View



#	Icon	Item	Description
1		DC-in jack	Connects to an AC adapter.
2		Modem (RJ-11) port	Connects to a phone line.
3		Ethernet (RJ-45) port	Connects to an Ethernet 10/100-based network.
4		External display (VGA) port	Connects to a display device (e.g., external monitor, LCD projector).
5	HDMI	HDMI port	Supports high definition digital video connections.
6		2 USB 2.0 ports	Connect to USB 2.0 devices (e.g., USB mouse, USB camera).
7		Headphones/speaker/line-out jack with S/PDIF support	Connects to audio line-out devices (e.g., speakers, headphones).
8		Microphone-in jack	Accepts input from external microphones.
9		Line-in jack	Accepts audio line-in devices (e.g., audio CD player, stereo walkman).

Right View



#	Icon	Item	Description
1		ExpressCard/54 slot	Accepts one ExpressCard/54 module.
2		Optical drive	Internal optical drive; accepts CDs or DVDs.
3		Optical disk access indicator	Lights up when the optical drive is active.
4		Optical drive eject button	Ejects the optical disk from the drive.
5		Emergency eject hole	Ejects the optical drive tray when the computer is turned off.
6		2 USB 2.0 ports	Connect to USB 2.0 devices (e.g., USB mouse, USB camera).
7		TV-in port	Accepts input signals from analog/digital TV-tuner devices (for selected models).
8		Kensington lock slot	Connects to a Kensington-compatible computer security lock.





Rear view

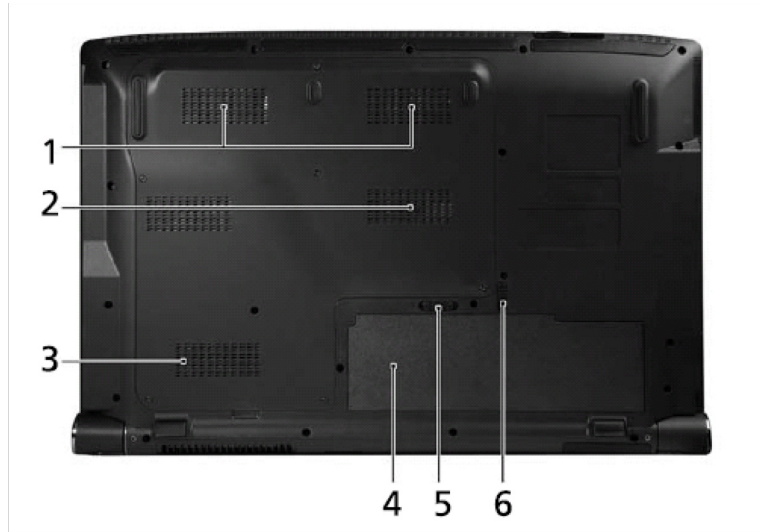

#	Icon	Item	Description
1		Tuba	The dedicated Tuba CineBass subwoofer pumps out earthshaking movie-house audio.
2		Ventilation slots	Enable the computer to stay cool, even after prolonged use.

Base view







#	Icon	Item	Description
1		Hard disk bay	Houses the computer's hard disk (secured with screws).
2		Memory compartment	Houses the computer's main memory.
3		Ventilation slots and cooling fan	Enable the computer to stay cool, even after prolonged use. Note: Do not cover or obstruct the opening of the fan.
4		Battery bay	Houses the computer's battery pack.
5		Battery release latch	Releases the battery for removal.
6		Battery lock	Locks the battery in position.

Indicators

The computer has several easy-to-read status indicators.



The front panel indicators are visible even when the computer cover is closed up.

Icon	Function	Description
	Power	Indicates the computer's power status.
	Battery	Indicates the computer's battery status.
	HDD	Indicates when the hard disk drive is active.
	Num Lock	Lights up when Num Lock is activated.
	Caps Lock	Lights up when Caps Lock is activated.

NOTE:







- 1. **Charging:** The light shows amber when the battery is charging.
- 2. **Fully charged:** The light shows green when in AC mode.

Easy-Launch Buttons

Located beside the keyboard are application buttons. These buttons are called easy-launch buttons. They are: WLAN, Internet, email, Bluetooth and Acer Empowering Technology.

The mail and Web browser buttons are pre-set to email and Internet programs, but can be reset by users. To set the Web browser, mail and programmable buttons, run the Acer Launch Manager.



Icon	Function	Description
	Empowering Technology	Launch Acer Empowering Technology. (user-programmable)
	Wireless communication button/indicator	Enables/disables the wireless function. Indicates the status of wireless LAN communication.
	Web browser	Internet browser (user-Programmable)
	Mail	Email application (user-Programmable)
	Bluetooth communication button/indicator	Enables/disables the Bluetooth function. Indicates the status of Bluetooth communication.

Touchpad Basics

The following teaches you how to use the touchpad:

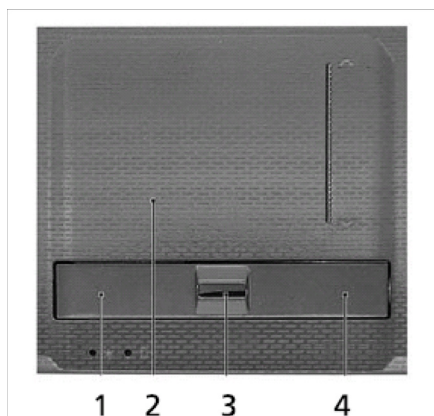

Move your finger across the touchpad (2) to move the cursor.

Press the left (1) and right (4) buttons located beneath the touchpad to perform selection and execution functions. These two buttons are similar to the left and right buttons on a mouse. Tapping on the touchpad is the same as clicking the left button.

Use the 4-way scroll (3) button to scroll up or down and move left or right a page. This button mimics your cursor pressing on the right scroll bar of Windows applications.

Function	Left button (1)	Right button (4)	Main touchpad (2)	Center button (3)
Execute	Quickly click twice.		Tap twice (at the same speed as double-clicking a mouse button).	
Select	Click once.		Tap once.	
Drag	Click and hold, then use finger on the touchpad to drag the cursor.		Tap twice (at the same speed as double-clicking a mouse button); rest your finger on the touchpad on the second tap and drag the cursor.	

Function	Left button (1)	Right button (4)	Main touchpad (2)	Center button (3)
Access context menu		Click once.		
Scroll				Swipe up/down/left/right using Acer FingerNav 4-way control function (for selected models) or click and hold to move up/down/left/right (for selected models).

NOTE: When using the touchpad, keep it - and your fingers - dry and clean. The touchpad is sensitive to finger movements; hence, the lighter the touch, the better the response. Tapping too hard will not increase the touchpad's responsiveness.

Using the Keyboard

The keyboard has full-sized keys and an embedded keypad, separate cursor keys, two Windows keys and twelve function keys.

Lock Keys and embedded numeric keypad



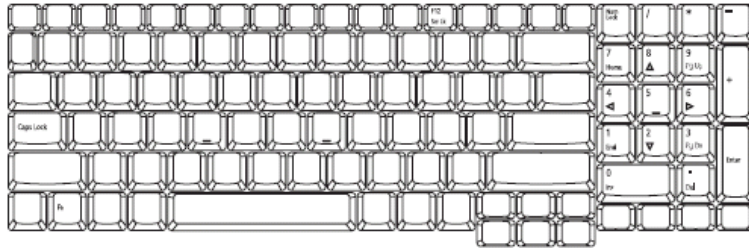















The keyboard has three lock keys which you can toggle on and off.



Lock key	Description
Caps Lock	When Caps Lock is on, all alphabetic characters typed are in uppercase.
Num Lock	When Num Lock is on, the separate keypad is in numeric mode. The keys function as a calculator (complete with the arithmetic operators +, -, *, and /). Use this mode when you need to do a lot of numeric data entry.
Scroll Lock <Fn> + <F12>	When Scroll Lock is on, the screen moves one line up or down when you press the up or down arrow keys respectively. Scroll Lock does not work with some applications.

Windows Keys

The keyboard has two keys that perform Windows-specific functions.

Key	Description
 Windows key	<p>Pressed alone, this key has the same effect as clicking on the Windows Start button; it launches the Start menu. It can also be used with other keys to provide a variety of functions:</p> <ul style="list-style-type: none"><  > : Open or close the Start menu<  > + <D>: Display the desktop<  > + <E>: Open Windows Explore<  > + <F>: Search for a file or folder<  > + <G>: Cycle through Sidebar gadgets<  > + <L>: Lock your computer (if you are connected to a network domain), or switch users (if you're not connected to a network domain)<  > + <M>: Minimizes all windows<  > + <R>: Open the Run dialog box<  > + <T>: Cycle through programs on the taskbar<  > + <U>: Open Ease of Access Center<  > + <X>: Open Windows Mobility Center<  > + <BREAK>: Display the System Properties dialog box<  > + <SHIFT+M>: Restore minimized windows to the desktop<  > + <TAB>: Cycle through programs on the taskbar by using Windows Flip 3-D<  > + <SPACEBAR>: Bring all gadgets to the front and select Windows Sidebar<CTRL> + <  > + <F>: Search for computers (if you are on a network)<CTRL> + <  > + <TAB>: Use the arrow keys to cycle through programs on the taskbar by using Windows Flip 3-D
 Application key	<p>This key has the same effect as clicking the right mouse button; it opens the application's context menu.</p>

Hot Keys

The computer employs hotkeys or key combinations to access most of the computer's controls like screen brightness, volume output and the BIOS utility.

To activate hot keys, press and hold the <Fn> key before pressing the other key in the hotkey combination.

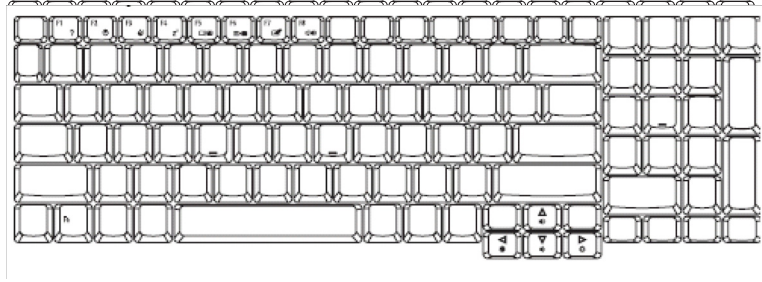

Hotkey	Icon	Function	Description
<Fn> + <F1>	?	Hotkey help	Displays help on hotkeys.
<Fn> + <F2>		Acer eSettings Management	Launches Acer eSettings Management in Acer Empowering Technology.
<Fn> + <F3>		Acer ePower Management	Launches Acer ePower Management in Acer Empowering Technology.
<Fn> + <F4>	Z ^z	Sleep	Puts the computer in Sleep mode.
<Fn> + <F5>		Display toggle	Switches display output between the display screen, external monitor (if connected) and both.
<Fn> + <F6>		Screen blank	Turns the display screen backlight off to save power. Press any key to return.
<Fn> + <F7>		Touchpad toggle	Turns the internal touchpad on and off.
<Fn> + <F8>		Speaker toggle	Turns the speakers on and off.
<Fn> + <↑>		Volume up	Increases the sound volume.
<Fn> + <↓>		Volume down	Decreases the sound volume.
<Fn> + <↔>		Brightness up	Increases the screen brightness.
<Fn> + <↔>		Brightness down	Decreases the screen brightness.

Special Key

You can locate the Euro symbol and US dollar sign at the upper-center and/or bottom-right of your keyboard. To type:

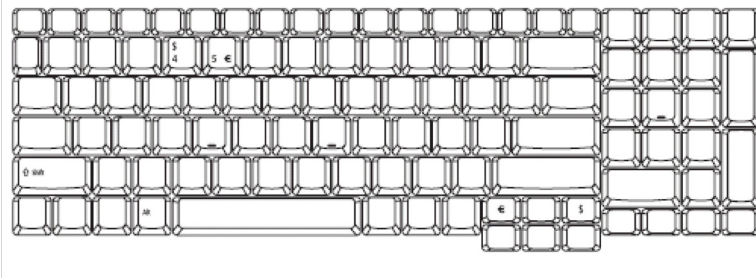

The Euro symbol

1. Open a text editor or word processor.
2. Either directly press the <€> symbol at the bottom-right of the keyboard, or hold <Alt Gr> and then press the<5> symbol at the upper-center of the keyboard.

NOTE: Some fonts and software do not support the Euro symbol. Please refer to www.microsoft.com/typography/faq/faq12.htm for more information.

The US dollar sign

1. Open a text editor or word processor.
2. Either directly press the <\$> key at the bottom-right of the keyboard, or hold <Shift> and then press the <4> key at the upper-center of the keyboard.

NOTE: This function varies by the operating system version.

Acer Empowering Technology

The Empowering Technology toolbar makes it easy for you to access frequently used functions and manage your new Acer system. Activated by pressing the Empowering Key, it provides access to the following utilities:



Note: The following content is for general reference only. Actual product specifications may vary.

- Acer eAudio Management allows you to easily control the enhanced sound effects of Dolby Home Theater on your system.
- Acer ePower Management optimizes battery usage via customizable power plans.
- Acer eDataSecurity Management protects data with passwords and encryption (for selected models).
- Acer eRecovery Management backs up and recovers data flexibly, reliably and completely.
- Acer eSettings Management accesses system information and adjusts settings easily.



For more information, right-click on the Empowering Technology toolbar, then select Help. For help with a particular utility, launch the utility and click the



icon at the bottom of the active window. Launching Acer Empowering Technology

To launch Acer Empowering Technology:

- 1 Press the Empowering Key to display the Acer Empowering Technology toolbar on the desktop.
- 2 To hide the toolbar, press the Empowering Key again or click the hide button on the toolbar.

You may also launch Acer Empowering Technology by running the program from the Acer Empowering Technology program group in the Start menu, or by double-clicking the icon if you have created a desktop shortcut.

To launch Acer Empowering Technology applications:

On the Acer Empowering Technology toolbar, click the icon that corresponds to the application you want to launch.

When you mouse over an application icon, a quick menu appears below the toolbar. The quick menu allows you to perform certain tasks simply and quickly.

You may also run the application by selecting it from the Acer Empowering Technology program group in the Start menu.



Acer eAudio Management

Acer eAudio Management allows you to easily control the enhanced sound effects of Dolby Home Theater on your system. Select Movie or Game mode to experience the awesome realism of 5.1-channel surround sound from just two speakers, via Dolby Virtual Speaker technology. Music mode lets you enjoy your favorite tunes, in vivid detail.



To choose your playback device, click the icon on the upper right side of the Acer eAudio Management window.

Acer ePower Management

Acer ePower Management features a straightforward user interface for configuring your power management options. To access this utility, select Acer ePower Management from the Empowering Technology toolbar, run the program from the Acer Empowering Technology program group in Start menu, or right-click the Windows power icon in the system tray and select Acer ePower Management.

Using power plan

Acer ePower Management comes with three predefined power plans: Balanced, High performance and Power saver. You can also create customized power plans. You can create, switch between, edit, delete and restore power plans, as described below

View and adjust settings for On Battery and Plugged In modes by clicking the appropriate tabs. For more power options, click in the Acer ePower and select Power Options.

To create a new power plan:

Creating customized power plans allows you to save and quickly switch to a personalized set of power options.

- 1 Click the New power plan option or icon .
- 2 Enter a name for your new power plan.
- 3 Choose a predefined power plan to base your customized plan on.
- 4 If necessary, change the display, sleep and hibernation settings you want your computer to use.
- 5 Click OK to save your new power plan.

To switch between power plans:

- 1 Mouse over the Acer ePower Management application on the Acer Empowering Technology toolbar. The quick menu appears
- 2 Select the power plan you want to switch to You may also switch between power plans by launching the Acer ePower Management application. Select the power plan you wish to switch to, then click Apply. click Apply

To edit a power plan:

Editing a power plan allows you to adjust system settings like LCD brightness and CPU speed.

- 1 Switch to the power plan you wish to edit.
- 2 Adjust settings as required.
- 3 Click Apply to save your new settings.

To delete a power plan:

You cannot delete the power plan you are currently using. If you want to delete the active power plan, switch to another one first.

- 1 Select the power plan you wish to delete.
- 2 Click the Delete Power Plan icon.

Battery status

The quick menu shows the remaining battery life based on current usage. You can also launch the Acer ePower Management application and refer to the Battery status panel located just below the power plans. Click the Battery tab to view remaining battery life, battery status, and remaining battery life in standby and hibernate modes.



Acer eDataSecurity Management

(for selected models) 

Acer eDataSecurity Management is an encryption utility that protects your files from being accessed by unauthorized persons. It is conveniently integrated with Windows Explorer as a shell extension for quick data encryption/decryption and also supports on-the-fly file encryption for Lotus Notes and Microsoft Outlook.

On first use, the Acer eDataSecurity Management setup wizard will prompt you to create the Master Password. You will use this password to access the Personal Secure Disk (PSD). The Master Password may also be used to encrypt/decrypt files by default.

If you set a different password to encrypt a file, but you forgot the encryption password, you can use the Master Password to decrypt the file.

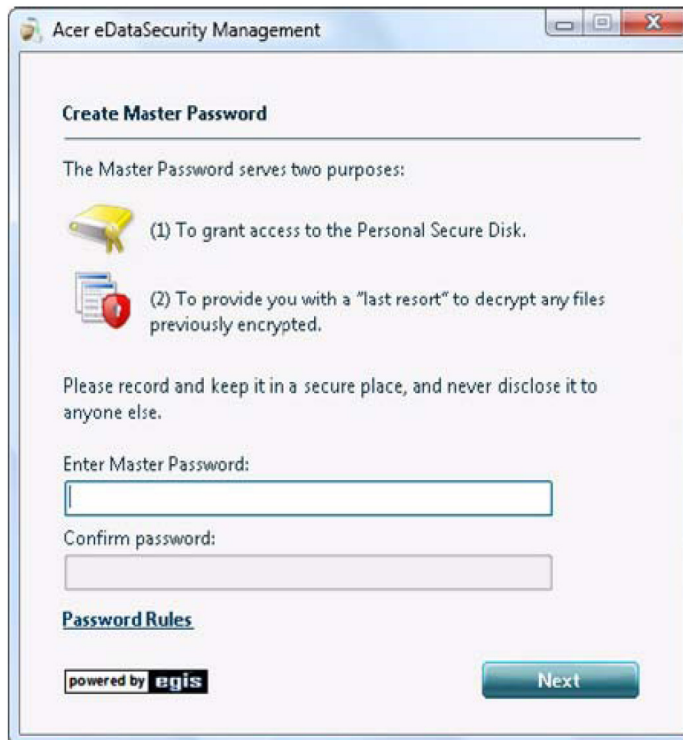

Acer eRecovery Management

Acer eRecovery Management is a versatile backup utility. It allows you to create full or incremental backups, burn the factory default image to optical disc, and restore from previously created backups or reinstall applications and drivers. By

default, user-created backups are stored to the D:\ drive.system's HDD. User-created backups are stored on D:\ drive. Acer eRecovery Management provides you with:

- Password protection.
- Recovery of applications and drivers.
- Image/data backup:
 - Back up to HDD (set recovery point).
 - Back up to CD/DVD.

Image/data recovery tools:

- Recover from a hidden partition (factory defaults).
- Recover from the HDD (most recent user-defined recovery point).
- Recover from CD/DVD.



For more information, please refer to “Acer eRecovery Management”

NOTE: If your computer did not come with a Recovery CD or System CD, please use Acer eRecovery Management’s “System backup to optical disk” feature to burn a backup image to CD or DVD. To ensure the best results when recovering your system using a CD or Acer eRecovery Management, detach all peripherals (except the external Acer ODD, if your computer has one), including your Acer ezDock.

Acer eSettings Management

Acer eSettings Management allows you to inspect hardware specifications and to monitor the system health status. Furthermore, Acer eSettings Management enables you to optimize your Windows operating system, so your computer runs faster, smoother and better.

Acer eSettings Management also:

Provides a simple graphical user interface for navigating.

Displays general system status and advanced monitoring for power users.

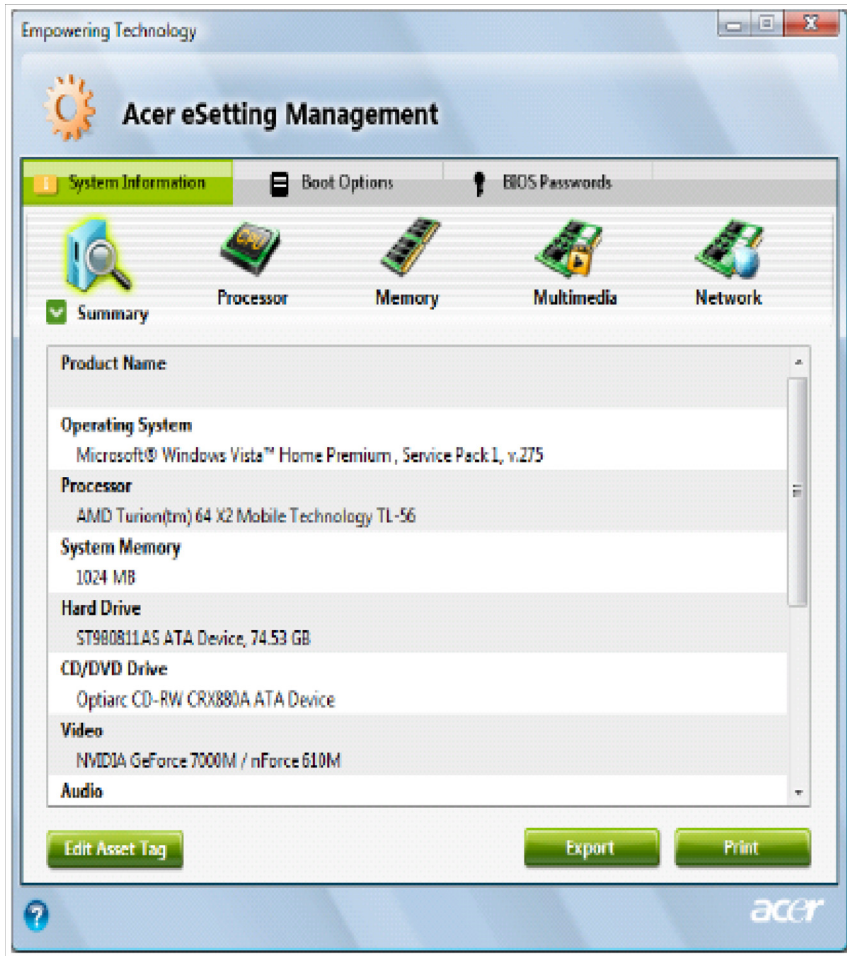

Windows Mobility Center

The Windows Mobility Center collects key mobile-related system settings in one easy-to-find place, so you can quickly configure your Acer system to fit the situation as you change locations, networks or activities. Settings include display brightness, power plan, volume, wireless networking on/off, external display settings, display orientation and synchronization status.

Windows Mobility Center also includes Acer-specific settings like Bluetooth Add Device (if applicable), sharing folders overview/sharing service on or off, and a shortcut to the Acer user guide, drivers and utilities. To launch Windows Mobility Center:

- Use the shortcut key <> + <X>.

- Start Windows Mobility Center from the Control panel.
- Start Windows Mobility Center from the Accessories program group in the Start menu.

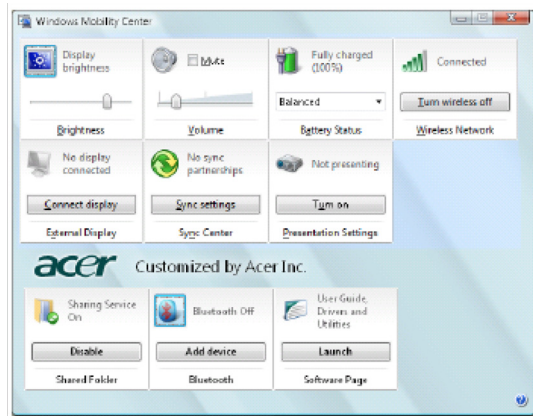

Using the System Utilities

Acer Bio-Protection (for selected models)

Acer Bio-Protection Fingerprint Solution is a multi-purpose fingerprint software package integrated with the Microsoft Windows operating system. Utilizing the uniqueness of one's fingerprint features, Acer Bio-Protection Fingerprint Solution has incorporated protection against unauthorized access to your computer with centralized password management with Password Bank, easy music player launching with Acer MusicLaunch, secure Internet favorites via Acer MyLaunch, and fast application/website launching and login with Acer FingerLaunch, while Acer ProfileLaunch can launch up to three applications/ websites from a single finger swipe.

Acer Bio-Protection Fingerprint Solution also allows you to navigate through web browsers and documents using Acer FingerNav. With Acer Bio-Protection Fingerprint Solution, you can now enjoy an extra layer of protection for your personal computer, as well as the convenience of accessing your daily tasks with a simple swipe of your finger

For more information refer to the Acer Bio-Protection help files.

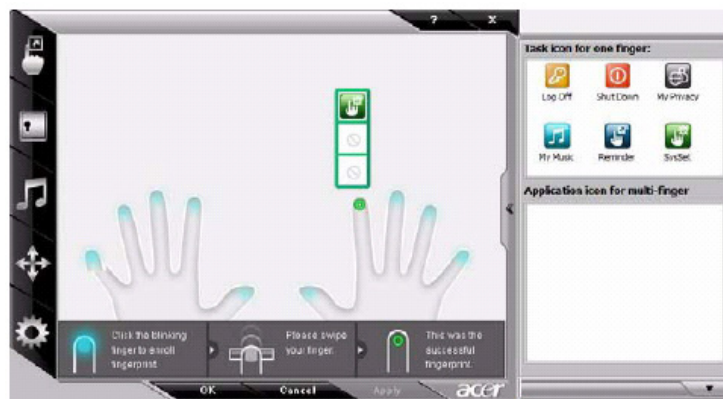

Acer GridVista (dual-display compatible)

Note: This feature is only available on certain models.

To enable the dual display feature of your notebook, first ensure that a second display is connected, then, open the Display Settings properties box using the Control Panel or by right-clicking the Windows desktop and selecting Personalize. Select the secondary monitor (2) icon in the display box and then click the check box Extend the desktop onto this monitor. Finally, click Apply to confirm the new settings and click OK to complete the process.

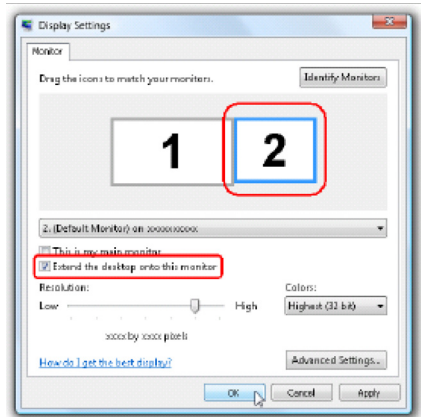

Acer GridVista is a handy utility that offers four pre-defined display settings so you can view multiple windows on the same screen. To access this function, please go to **Start>All Programs** and click on **Acer GridVista**. You may choose any one of the four display settings indicated below:



Double (verticle), Triple (primary at left), Triple (primary at right), or Quad Acer Gridvista is dual-display compatible, allowing two displays to be partitioned indepently.

Acer Gridvista is dual-display compatible, allowing two displays to be partitioned independently.

AcerGridVista is imple to set up:

1. Run Acer GridVista and select your preferred screen configuration for each display from the task bar.
2. Drag and drop each window into the appropriate grid.
3. Enjoy the convenience of a well-organized desktop.

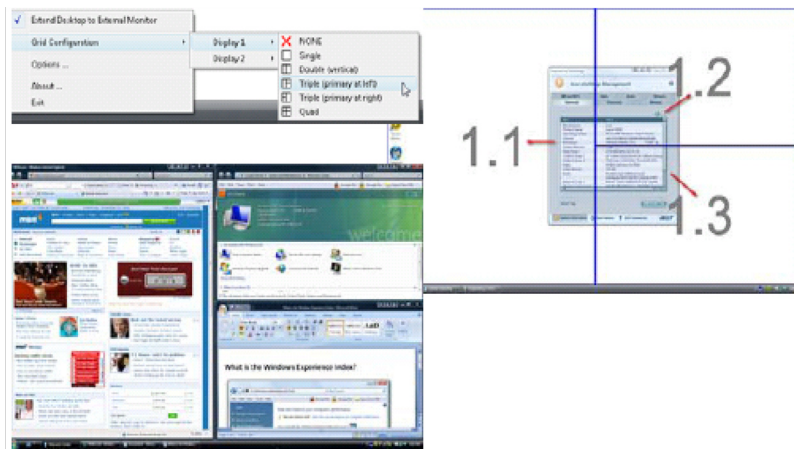

NOTE: Please ensure that the resolution setting of the second monitor is set to the manufacturer's recommended value.

Launch Manager

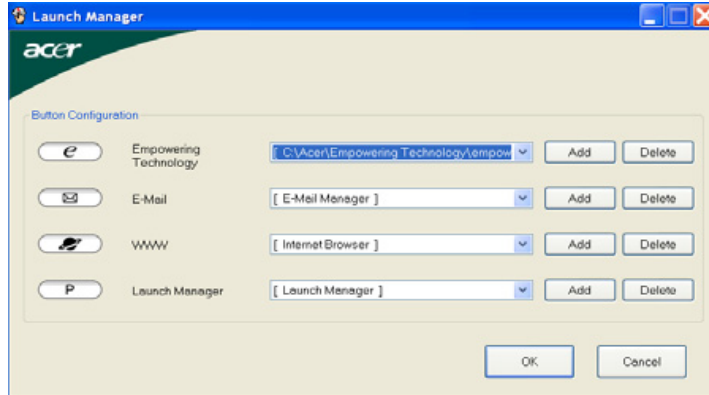

Launch Manager allows you to set the four easy-launch buttons located above the keyboard. You can access the Launch Manager by clicking on Start > All Programs > Launch Manager to start the application.

Hardware Specifications and Configurations

Processor	
Item	Specification
CPU type	Intel CPU Penryn
Core logic	Intel 965PM + ICH8M
CPU package	uFCPGA, Socket P
CPU core voltage	0.944~1.3V

NOTE: If you need to check PXE version, press F2 to enter BIOS then enable boot from LAN function. After that, power off the system and remove the HDD. Last, reboot the laptop. Then you will see PXE version displaying on the screen.

Item	Specification
BIOS vendor	Phoenixix
BIOS ROM type	Flash ROM
BIOS ROM size	512KB
BIOS package	8-pin PLCC
Supported protocols	ACPI 1.0b/2.0/3.0, PCI 2.2, System/HDD Password Security Control, INT 13h Extensions, PnP BIOS 1.0a, SMBIOS 2.4, Simple Boot Flag 1.0, Boot Block, PCI Bus Power Management Interface Specification, USB1.1/2.0, IEEE 1394 1.0, USB/1394 CD-ROM Boot Up support, PC Card 95 (PCMCIA 3.0 Compliant Device), IrDA 1.0, Intel AC97 CNR Specification, WfM 2.0, PXE (Preboot Execution Environment), BIS 1.0 (Boot Integrity Service Application Program Interface), PC99a and Mobile PC2001 Compliant, Intel Enganced SpeedStep Technology
BIOS password control	Set by setup manual

Second Level Cache	
Item	Specification
Cache controller	Built-in CPU
Cache size	6MB
1st level cache control	Always enabled
2st level cache control	Always enabled

Cache scheme control	Fixed in write-back
----------------------	---------------------

System Memory	
Item	Specification
Memory controller	Intel PM965
Memory size	0MB (no on-board memory)
DIMM socket number	2 sockets
Supports memory size per socket	2GB
Supports maximum memory size	4GB
Supports DIMM type	DDR 2 Synchronous DRAM
Supports DIMM Speed	533/667 MHz
Supports DIMM voltage	1.8V and 0.9V
Supports DIMM package	200-pin soDIMM

Memory Combinations		
Slot 1	Slot 2	Total Memory
0MB	256MB	256MB
0MB	512MB	512MB
0MB	1024MB	1024MB
0MB	2048MB	2048MB
256MB	256MB	512MB
256MB	512MB	768MB
256MB	1024MB	1280MB
256MB	2048MB	2304MB
512MB	256MB	768MB
512MB	512MB	1024MB
512MB	1024MB	1536MB
512MB	2048MB	2560MB
1024MB	0MB	1024MB
1024MB	256MB	1280MB
1024MB	512MB	1536MB
1024MB	1024MB	2048MB
1024MB	2048MB	3072MB
2048MB	0MB	2048MB
2048MB	256MB	2304MB
2048MB	512MB	2560MB
2048MB	1024MB	3072MB
2048MB	2048MB	4096MB

NOTE: Above table lists some system memory configurations. You may combine DIMMs with various capacities to form other combinations. On above table, the configuration of slot 1 and slot 2 could be reversed.

LAN Interface	
Item	Specification
Chipset	ATHEROS_AR8121
Supports LAN protocol	10/100/1000 Ethernet
PCI-E Giga	

LAN connector type	RJ45
LAN connector location	Left side
Features	Integrated 10/100/1000 BASE-T transceiver

Modem Interface	
Item	Specification
Data modem data baud rate (bps)	56K
Supports modem protocol	V.92
Modem connector type	RJ11
Modem connector location	Left side

Bluetooth Interface	
Item	Specification
Chipset	Built-in ICH8M
Data throughput	723 bps (full speed data rate)
Protocol	Bluetooth 1.1 (Upgradeable to Bluetooth 1.2 when SIG specification is ratified).
Interface	USB 2.0
Connector type	USB

Item	Specification
Chipset	Built-in ICH8M
Data throughput	540 Mbps
Protocol	802.11AGN
Interface	PCI

Hard Disk Drive Interface	
Item	Specification
Vendor & Model Name	HGST HTS541680J9SA00
WD WD800BEVS-22RST0	Seagate ST9120822AS
	Toshiba MK1237GSX
	HGST HTS541612J9SA00

WD WD1200BEVS-22RST0	TOSHIBA MK1637GSX
	SEAGATE ST9160821AS
	HGST HTS541616J9SA00
	WD WD1600BEVS-22RST0
Capacity (MB)	80000
Bytes per sector	512
Data heads	2
4 for Toshiba and HGST	4
Drive Format	
Disks	1
Spindle speed (RPM)	5400 RPM

Performance Specifications	
Buffer size	8M
Interface	SATA
Max. media transfer rate (disk-buffer, Mbytes/s)	100,150
Data transfer rate (host~buffer, Mbytes/s)	
Ultra DMA mode-5	100 MB/Sec.
Ultra DMA mode-5	100 MB/Sec.
Ultra DMA mode-5	100 MB/Sec.
DC Power Requirements	
Voltage tolerance	5V(DC) +/- 5%
Data transfer rate (host~buffer, Mbytes/s)	
Ultra DMA mode-5	100 MB/Sec.
Ultra DMA mode-5	100 MB/Sec.
Ultra DMA mode-5	100 MB/Sec.
DC Power Requirements	
Voltage tolerance	5V(DC) +/- 5%

Audio Interface	
Item	Specification
Audio Controller	Realtek ALC889X
Audio onboard or optional	Built-in

Mono or Stereo	Stereo
Resolution	24 bit stereo full duplex
Compatibility	HD audio Interface; S/PDIF output for PCM or AC-3 content
Sampling rate	1Hz resolution VSR (Variable Sampling Rate)
Internal microphone	Yes
Internal speaker / Quantity	Yes/2(3W speakers)
Supports PnP DMA channel	DMA channel 0
DMA channel 1	
Supports PnP IRQ	IRQ10, IRQ11

DVD-SuperMulti Interface	
Item	Specification
Vendor & model name	TOSHIBA 8X TS-L632D
	PHILIPS 8X DS-8A1P
	HLDS 8X GSA-T20N
Performance Specification	With CD Diskette
Transfer rate (KB/sec)	Sustained:Max 3.6Mbytes/sec
	Sustained:Max 10.8Mbytes/sec
Buffer Memory	2MB
Interface	Enhanced IDE(ATAPI) compatible
Applicable disc format	
Support disc formats	1. Reads data in each CD-ROM, CD-ROM XA, CD-1, Video CD, CD-Extra and CD-Plus
	2. Reads data in super Audio CD (SACD) Hybrid type
	3. Reads standard CD-DA
	4. Reads and writes CD-R discs
	5. Reads and writes CD-RW and HSRW discs
	6. Reads and writes US & US+RW
	7. Reads data in each DVD-ROM and DVD-Dual
	8. Reads and writes in each DVD-R (Ver. 2.0 for general), DVD-RW and DVD+R/RW (Ver1.1)
	9. Reads and writes DVD+-R Dual
	10. Reads and writes DVD-RAM
Loading mechanism	Load: Manual
	Release: (a) Electrical Release (Release Button)

	(b) Release by ATAPI command
	(c) Emergency Release
Power Requirement	
Input Voltage	5 V +/- 5 % (Operating)

Video Interface	
Item	Specification
Chipset	Acer MXM compatible

USB Port	
Item	Specification
Chipset	Built-in ICH8M
USB Compliancy Level	2
OHCI	USB 1.1 and USB 2.0 Host controller
Number of USB port	4
Location	One on the left side; three on the right side
Serial port function control	Enable/Disable by BIOS Setup

Express Card Interface	
Item	Specification
Express card controller	Built-in ICH8M
Supports card type	75mmx54mm(W)x5mm
Number of slots	One
Access location	Left Side
Interface	PCI Express

System Board Major Chips	
Item	Controller
Core logic	Intel PM965 + ICH8M
VGA	Acer MXM compatible
LAN	ATHEROS_AR8121
USB 2.0	Built in ICH8M

CardReader	Jmicro JMB385
MODEM	Foxconn T60M955
Bluetooth	Foxconn T60H928.11
Wireless 802.11 a+b+g	Built-in ICH8-M
Audio	Realtek ALC889X

Keyboard	
Item	Specification
Keyboard controller	ITE 8512E
Total number of keypads	88-/89-key
Windows logo key	Yes
Internal & external keyboard work simultaneously	Plug USB keyboard to the USB port directly: Yes

Battery	
Item	Specification
Vendor & model name	BATTERY PACK SANYO LI-ION 8 CELL2.4, 4800MAH
	BATTERY PACK SONY LI-ION 8CELL2.4, 4800MAH
Battery Type	Li-ion
Pack capacity	4800 mAh
Number of battery cell	8
Package configuration	4 cells in series, 2 series in parallel
Normal voltage	14.8V
Charge voltage	16.8+-0.2V

LCD 18.0" inch	
Item	Specification
Vendor & model name	Samsung LNT184HT01-A01
Screen Diagonal (mm)	18.4 inches
Active Area (mm)	353.45(H) x 198.72(V) mm
Display resolution (pixels)	1920x1080 WUXGA
Pixel Pitch	0.213 (H) x 0.213(V) mm
Pixel Arrangement	R.G.B. Vertical Stripe

Display Mode	Normally White
Typical White Luminance (cd/m ²)	
also called Brightness	300
Luminance Uniformity	N/A
Contrast Ratio	600
Response Time (Optical Rise Time/Fall Time)msec	8
Nominal Input Voltage VDD	+3.3V
Typical Power Consumption (watt)	4.5W
Weight(g)	550g
Physical Size(mm)	365x214x6.5
Electrical Interface	Dual channel LVDS
Support Color	262,144
Viewing Angle (degree)	
Horizontal: Right/Left	65/65
Vertical: Upper/Lower	50/50
Temperature Range(C)	
	Operating
	Storage (shipping)
	0 to +50 / -20 to +60

LCD Inverter	
Item	Specification
Vendor & model name	TDK
Brightness conditions	N/A
Input voltage (V)	9~20V
Input current (mA)	360mA (max)
Output voltage (V, rms)	710V (1800V for kick off)
Output current (mA, rms)	6.5mA (max)
Output voltage frequency (k Hz)	58 KHz (max)

AC Adaptor	
Item	Specification
Input rating	100V AC to 240V AC, 47Hz to 63Hz

Maximum input AC current	1.5A
Inrush current	50A@115VAC
	100A@230VAC
Efficiency	85% min. @115VAC input full load

System Power Management	
ACPI mode	Power Management
Mech. Off (G3)	All devices in the system are turned off completely.
Soft Off (G2/S5)	OS initiated shutdown. All devices in the system are turned off completely.
Working (G0/S0)	Individual devices such as the CPU and hard disc may be power managed in this state.
Suspend to RAM (S3)	CPU set power down
	VGA Suspend
	PCMCIA Suspend
	Audio Power Down
	Hard Disk Power Down
	CD-ROM Power Down
	Super I/O Low Power mode
Save to Disk (S4)	Also called Hibernation Mode. System saves all system states and data onto the disc prior to power off the whole system.

System Utilities

BIOS Setup Utility

The BIOS Setup Utility is a hardware configuration program built into your computer's BIOS (Basic Input/Output System).

Your computer is already properly configured and optimized, and you do not need to run this utility. However, if you encounter configuration problems, you may need to run Setup. Please also refer to Chapter 4 Troubleshooting when problem arises.

To activate the BIOS Utility, press **m** during POST (when "Press <F2> to enter Setup" message is prompted on the bottom of screen).

Press **m** to enter setup. The default parameter of F12 Boot Menu is set to "disabled". If you want to change boot device without entering BIOS Setup Utility, please set the parameter to "enabled".

Press <F12> during POST to enter multi-boot menu. In this menu, user can change boot device without entering BIOS SETUP Utility.

Phoenix TrustedCore Setup Utility					
Information	Main	Advanced	Security	Boot	Exit
CPU Type:	<u>Genuine Intel (R)® CPU</u>		Xxxx		
CPU Speed:	XXXX GHz				
IDE0 Model Name:	TOSHIBA MK3018GAP-(PM)		(note)		
IDE0 Serial No:	Y2554027T		(note)		
ATAPI Model Name	Slimtype DVD-ROM LSD-081-(SM)				
System BIOS Version:	V1.00				
VGA BIOS Version:	ATI M9+XC V0.1				
Serial Number:	xxxxxxxxxxxxxxxxxxxx		22 Byte		
Asset Tag Number:			32 Byte		
Product Name:	TravelMate xxxx		16 Byte		
Manufacturer Name:	Acer		16 Byte		
UUID:	xxxxxxxxxxxxxxxxxxxx		16 Byte		
F1 Help	↑↓ Select Item	F5/F6 Change Values	F9 Setup defaults		
Esc Exit	←→ Select Menu	Enter Select ▶ Sub-Menu	F10 Save and Exit		

Invoking BIOS Setup

The setup function can only be invoked by pressing F2 when Press <F2> to enter Setup message is prompted on the bottom of screen during POST.

The setup uses a menu driven interface to allow the user to configure their system. The features are divided into 6 parts as follows:

Information	Display the system informations.
Main	allows the user to specify standard IBM PC AT system parameters.
Advanced	Provides advanced settings of the system.
Security	Provides security settings of the system.
Boot	Allows the user to specify the boot options.
Exit	Allows the user to save CMOS setting and exit Setup.

NOTE: You can change the value of a parameter if it is enclosed in square brackets. Navigation keys for a particular menu are shown on the bottom of the screen. Help for parameters are found in the Item Specific Help part of the screen. Read this carefully when making changes to parameter values. **Please note that system information is subject to different models.**

Information

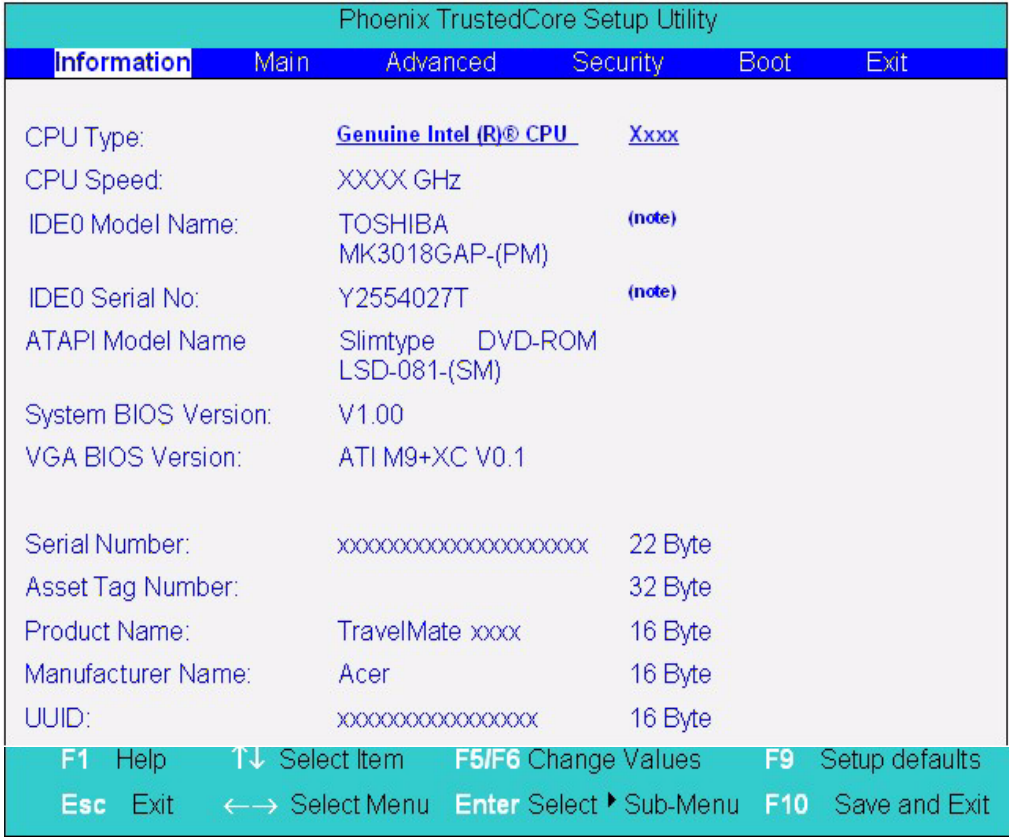

NOTE: The system information is subject to different models.

Parameter	Description
CPU Type	This field shows the CPU type and speed of the system.
IDE1 Model Name	This field shows the model name of HDD installed on primary IDE master.
IDE1 Serial Number	This field displays the serial number of HDD installed on primary IDE master.
IDE2I Model Name	This field displays the mofel name of devices installed on secondary IDE master. The hard disk drive or optical drive model name is automatically detected by the system.
IDE2 Serial Number	This field shows the serial number of devices installed on secondary IDE master.
System BIOS ver	Displays system BIOS version.
VGA BIOS Ver	This field displays the VGA firmware version of the system.
KBC Ver	This field shows the keyboard
Serial Number	This field displays the serial number of this unit.
Asset Tag Number	This field displays the asset tag number of the system.
Product Name	This field shows product name of the system.
Manufacturer Name	This field displays the manufacturer of this system.

Parameter	Description
UUID Number	This will be visible only when an internal LAN device is presenting. UUID=32bytes

Main

The Main screen displays a summary of your computer hardware information, and also includes basic setup parameters. It allows the user to specify standard IBM PC AT system parameters.

Phoenix TrustedCore Setup Utility					
Information	Main	Advanced	Security	Boot	Exit
Item specific Help					
System Time:		[09:00:00]			
System Date:		[01/01/2007]	<Tab>, <Shift-Tab>, or <Enter> selects field		
Total Memory:		XXXX MB			
Video Memory:		[8M] <small>Note2</small>			
Quiet Boot:		[Enabled]			
Network Boot		[Enabled]			
F12 Boot Menu		[Disabled]			
D2D Recovery		[Enabled]			
SATA Mode		[AHCI Mode]			
F1 Help	↑↓ Select Item	F5/F6 Change Values	F9 Setup defaults		
Esc Exit	←→ Select Menu	Enter Select	▶ Sub-Menu	F10 Save and Exit	

NOTE: The screen above is for your reference only. Actual values may differ.

The table below describes the parameters in this screen. Settings in **boldface** are the default and suggested parameter settings.

Parameter	Description	Format/Option
System Time	Sets the system time. The hours are displayed with 24-hour format.	Format: HH:MM:SS (hour:minute:second) System Time
System Date	Sets the system date.	Format MM/DD/YYYY (month/day/year) System Date
System Memory	This field reports the memory size of the system. Memory size is fixed to 640MB	
Extended Memory	This field reports the memory size of the extended memory in the system. Extended Memory size=Total memory size-1MB	
VGA Memory	Shows the VGA memory size. VGA Memory size=64/128MB	
Quiet Boot	Determines if Customer Logo will be displayed or not; shows Summary Screen is disabled or enabled. Enabled: Customer Logo is displayed, and Summary Screen is disabled. Disabled: Customer Logo is not displayed, and Summary Screen is enabled.	Option: Enabled or Disabled
Power on display	Auto: During power process, the system will detect if any display device is connected on external video port. If any external display device is connected, the power on display will be in CRT (or projector) only mode. Otherwise it will be in LCD only mode. Both: Simultaneously enable both the integrated LCD screen and the system's external video port (for an external CRT or projector).	Option: Auto or Both
Network Boot	Enables, disables the system boot from LAN (remote server).	Option: Enabled or Disabled
F12 Boot Menu	Enables, disables Boot Menu during POST.	Option: Disabled or Enabled
D2D Recovery	Enables, disables D2D Recovery function. The function allows the user to create a hidden partition on hard disc drive to store operation system and restore the system to factory defaults.	Option: Enabled or Disabled

NOTE: The sub-items under each device will not be shown if the device control is set to disable or auto. This is because the user is not allowed to control the settings in these cases.

Advanced

The Advanced screen displays advanced settings in BIOS.

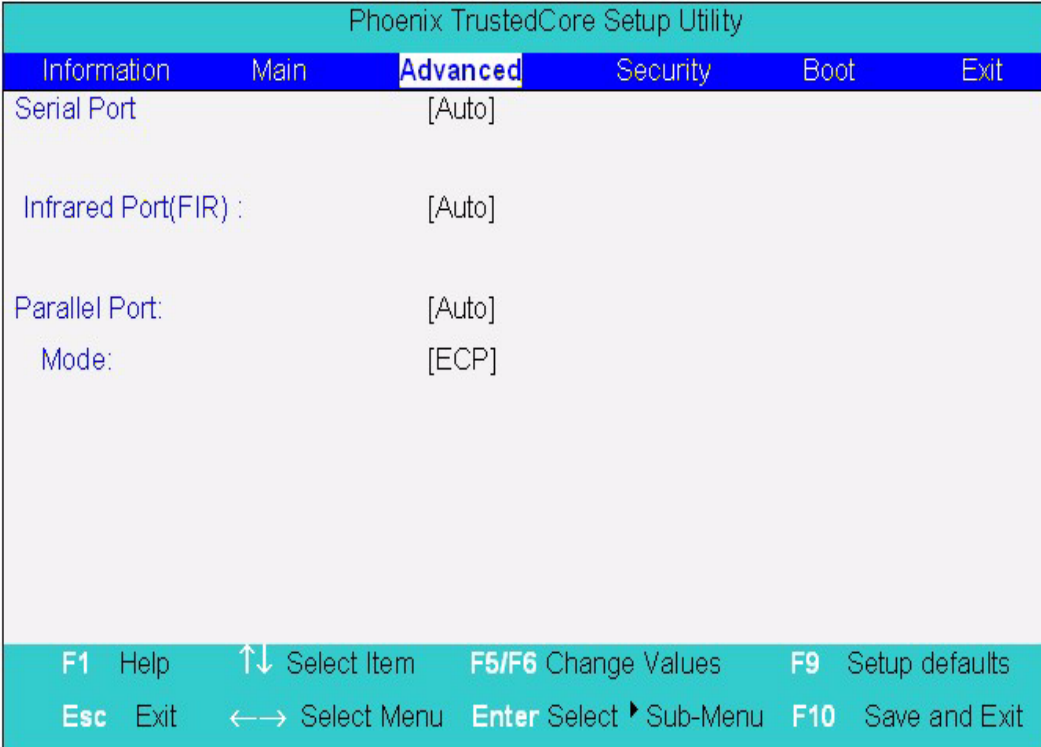

The table below describes the parameters in this screen. Settings in **boldface** are the default and suggested parameter settings.

Parameter	Description	Option
Serial port	Displays the settings of the serial port	Enabled or Disabled
Parallel port	Shows the settings of the parallel port	Enabled or Disabled

Security

The Security screen contains parameters that help safeguard and protect your computer from unauthorized use.

Phoenix TrustedCore Setup Utility					
Information	Main	Advanced	Security	Boot	Exit
				Item specific Help	
	Supervisor Password Is	Clear			
	User Password Is	Clear			
	HDD Password Is:	Clear <small>(Note1)</small>			
	Set Supervisor Password	[Enter]			
	Set User Password	[Enter]			
	Set HDD Password	[Enter]			
	Password on Boot:	[Disabled]			
F1	Help	↑↓ Select Item	F5/F6 Change Values	F9 Setup defaults	
Esc	Exit	←→ Select Menu	Enter Select ▸ Sub-Menu	F10 Save and Exit	

The table below describes the parameters in this screen. Settings in **boldface** are the default and suggested parameter settings.

Parameter	Description	Option
User Password is	Shows the setting of the user password.	Clear or Set
Supervisor Password is	Shows the setting of the Supervisor password	Clear or Set
Set User Password	Press Enter to set the user password. When user password is set, this password protects the BIOS Setup Utility from unauthorized access. The user can enter Setup menu only and does not have right to change the value of parameters.	
Set Supervisor Password	Press Enter to set the supervisor password. When set, this password protects the BIOS Setup Utility from unauthorized access. The user can not either enter the Setup menu nor change the value of parameters.	
HardDisk Security	Enables or disables primary hard disk security function.	
Password on Boot	Defines whether a password is required or not while the events defined in this group happened. The following sub-options are all requires the Supervisor password for changes and should be grayed out if the user password was used to enter setup.	Disabled or Enabled

NOTE: When you are prompted to enter a password, you have three tries before the system halts. Don't forget your password. If you forget your password, you may have to return your notebook computer to your dealer to reset it.

Setting a Password

Follow these steps as you set the user or the supervisor password:

1. Use the **w** and **y** keys to highlight the Set Supervisor Password parameter and press the **e** key. The Set Supervisor Password box appears:

Set Supervisor Password

Enter New Password []

Confirm New Password []

2. Type a password in the "Enter New Password" field. The password length can not exceeds 8 alphanumeric characters (A-Z, a-z, 0-9, not case sensitive). Retype the password in the "Confirm New Password" field.

IMPORTANT: Be very careful when typing your password because the characters do not appear on the screen.

3. Press **e**.
After setting the password, the computer sets the User Password parameter to "Set".
4. If desired, you can opt to enable the Password on boot parameter.
5. When you are done, press **u** to save the changes and exit the BIOS Setup Utility.

Removing a Password

Follow these steps:

1. Use the **w** and **y** keys to highlight the Set Supervisor Password parameter and press the **e** key. The Set Password box appears:

Set Supervisor Password		
Enter current password	[]
Enter New Password	[]
Confirm New Password	[]

2. Type the current password in the Enter Current Password field and press **e**.
3. Press **e** twice **without** typing anything in the Enter New Password and Confirm New Password fields. The computer then sets the Supervisor Password parameter to "Clear".
4. When you have changed the settings, press **u** to save the changes and exit the BIOS Setup Utility.

Changing a Password

1. Use the **w** and **y** keys to highlight the Set Supervisor Password parameter and press the **e** key. The Set Password box appears:

Set Supervisor Password		
Enter current password	[]
Enter New Password	[]
Confirm New Password	[]

2. Type the current password in the Enter Current Password field and press **e**.
3. Type a password in the Enter New Password field. Retype the password in the Confirm New Password field.
4. Press **e**. After setting the password, the computer sets the User Password parameter to "Set".
5. If desired, you can enable the Password on boot parameter.
6. When you are done, press **u** to save the changes and exit the BIOS Setup Utility.

If the verification is OK, the screen will display as following.

Setup Notice
Changes have been saved.
[continue]

The password setting is complete after the user presses **u**.

If the current password entered does not match the actual current password, the screen will show you the Setup Warning.

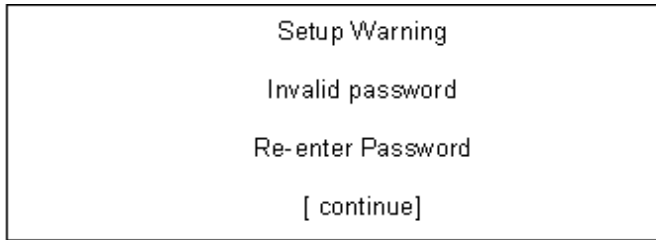

Setup Warning
Invalid password
Re-enter Password
[continue]

If the new password and confirm new password strings do not match, the screen will display the following message.

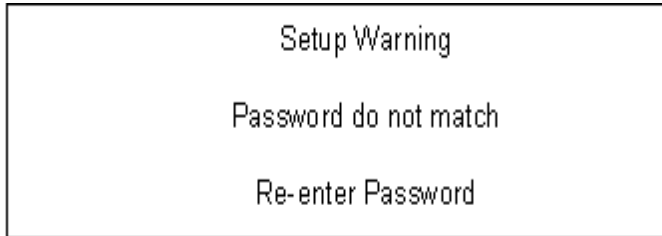

Setup Warning
Password do not match
Re-enter Password

Boot

This menu allows the user to decide the order of boot devices to load the operating system. Bootable devices includes the distette drive in module bay, the onboard hard disk drive and the CD-ROM in module bay.

Phoenix TrustedCore Setup Utility					
Information	Main	Advanced	Security	Boot	Exit
			Item specific Help		
Boot priority order :			Use <↑> or <↓> to select a device, then press <F6> to move it up the List, or <F5> to move it down the list. Press <Esc> to escape the menu		
1: IDE0 : WDC WD200EB -(PM)					
2: IDE1: WDC WD200EB -(PM)					
3: CD/DVD					
4: PCI LAN					
5. USB HDD					
6. USB FDD					
7. USB Key					
8. USB CD/DVD ROM					
F1 Help ↑↓ Select Item F5/F6 Change Values F9 Setup defaults Esc Exit ←→ Select Menu Enter Select ▸ Sub-Menu F10 Save and Exit					

Exit

The Exit screen contains parameters that help safeguard and protect your computer from unauthorized use.

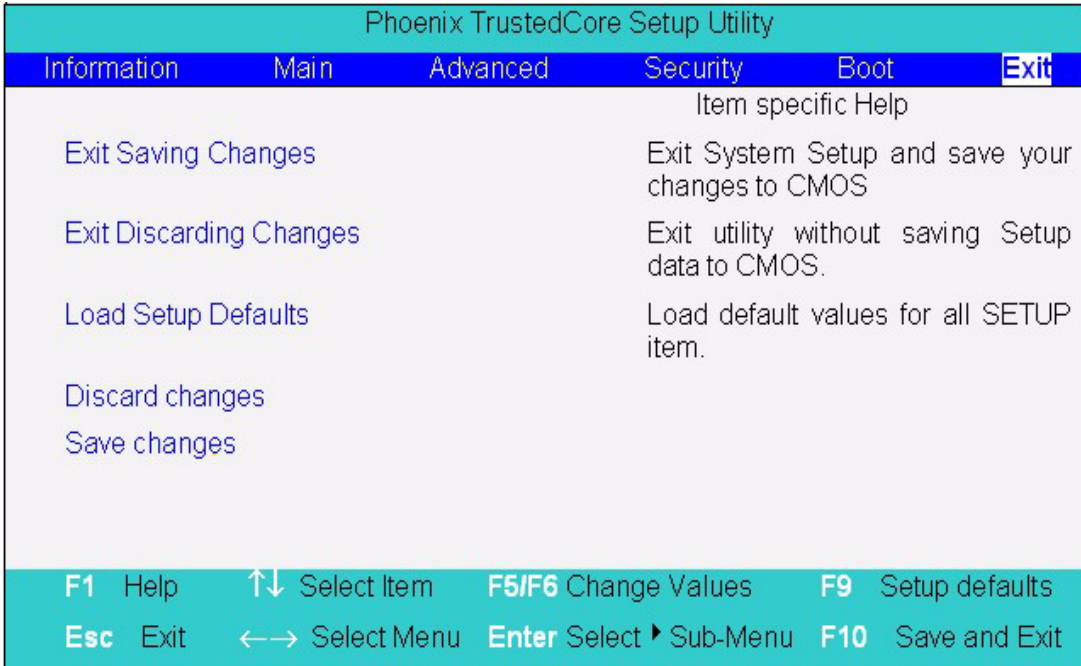

The table below describes the parameters in this screen.

Parameter	Description
Exit Saving Changes	Exit System Setup and save your changes to CMOS.
Exit Discarding Changes	Exit utility without saving setup data to CMOS.
Load Setup Default	Load default values for all SETUP item.
Discard Changes	Load previous values from CMOS for all SETUP items.
Save Changes	Save Setup Data to CMOS.

BIOS Flash Utility

The BIOS flash memory update is required for the following conditions:

- New versions of system programs
- New features or options
- Restore a BIOS when it becomes corrupted.

Use the Phlash utility to update the system BIOS flash ROM.

NOTE: If you do not have a crisis recovery diskette at hand, then you should create a **Crisis Recovery Diskette** before you use the Phlash utility.

NOTE: Do not install memory-related drivers (XMS, EMS, DPMS) when you use the Phlash.

NOTE: Please use the AC adaptor power supply when you run the Phlash utility. If the battery pack does not contain enough power to finish BIOS flash, you may not boot the system because the BIOS is not completely loaded.

Follow the steps below to run the Phlash.

1. Prepare a bootable diskette.
2. Copy the flash utilities to the bootable diskette.
3. Then boot the system from the bootable diskette. The flash utility has auto-execution function.

Remove HDD password Utility

This section provide you with removing HDD password method:

Remove HDD Password:

If you key in wrong HDD password for three time, "HDD password error code" would display on the screen. See the image below.

If you need to solve HDD password locked problem, you can run unlock6.EXE

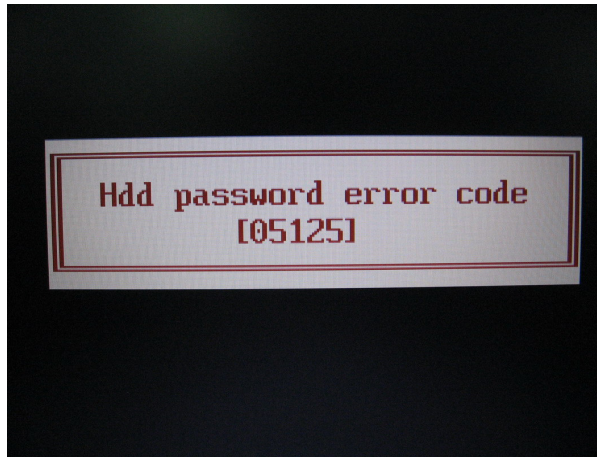

1. Key in "unlock6 error code 205"
2. Select "2"
3. Choose one HDD password

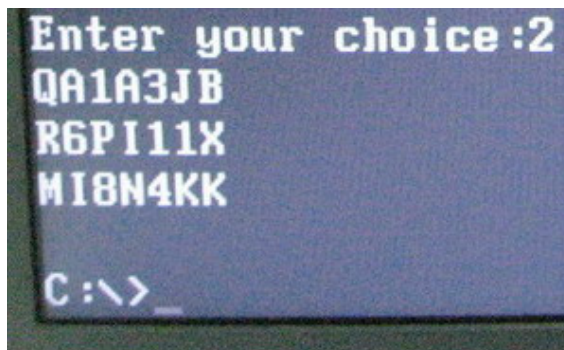

Reboot system and key in "R6PI11X" or "MI8N4KK" to HDD user password.

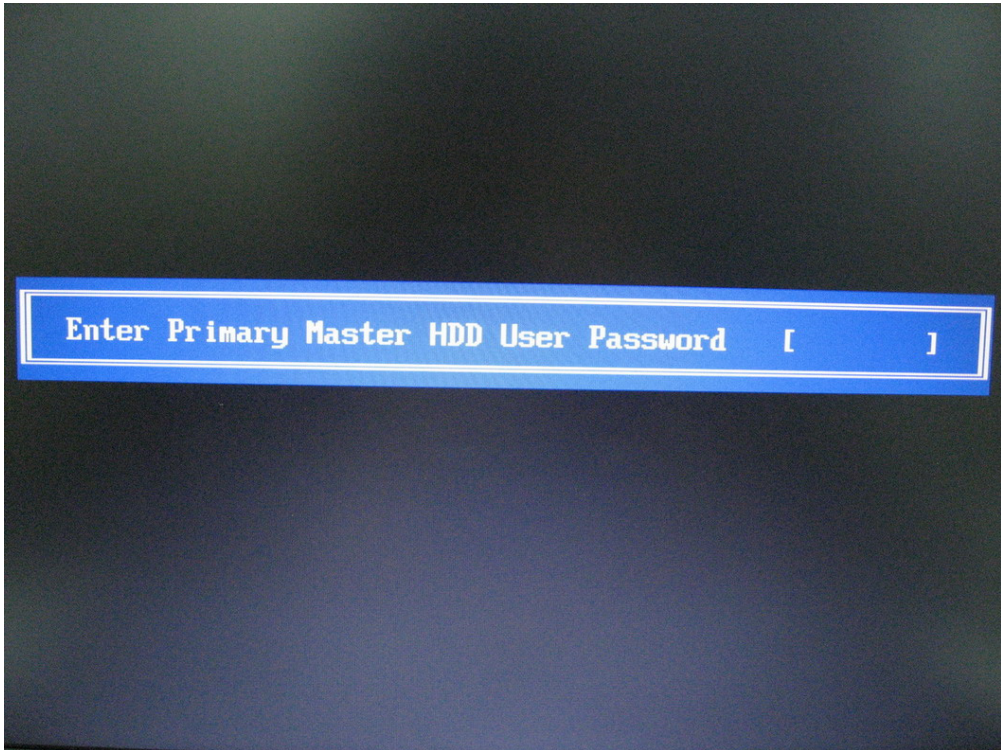

Then the HDD password will be unlocked and will auto into Windows after reboot.

Machine Disassembly and Replacement

This chapter contains step-by-step procedures on how to disassemble the notebook computer Aspire 8920 for maintenance and troubleshooting.

To disassemble the computer, you need the following tools:

- Wrist grounding strap and conductive mat for preventing electrostatic discharge
- Small Philips screw driver
- hilips screwdriver
- Plastic flat head screw driver
- Tweezers

NOTE: The screws for the different components vary in size. During the disassembly process, group the screws with the corresponding components to avoid mismatch when putting back the components. When you remove the stripe cover, please be careful not to scrape the cover.

General Information

Before You Begin

Before proceeding with the disassembly procedure, make sure that you do the following:

1. Turn off the power to the system and all peripherals.
2. Unplug the AC adapter and all power and signal cables from the system.
3. Remove the battery pack.

Disassembly Procedure Flowchart

The flowchart on the succeeding page gives you a graphic representation on the entire disassembly sequence and instructs you on the components that need to be removed during servicing. For example, if you want to remove the system board, you must first remove the keyboard, then disassemble the inside assembly frame in that order.

Main unit disassembly flow chart

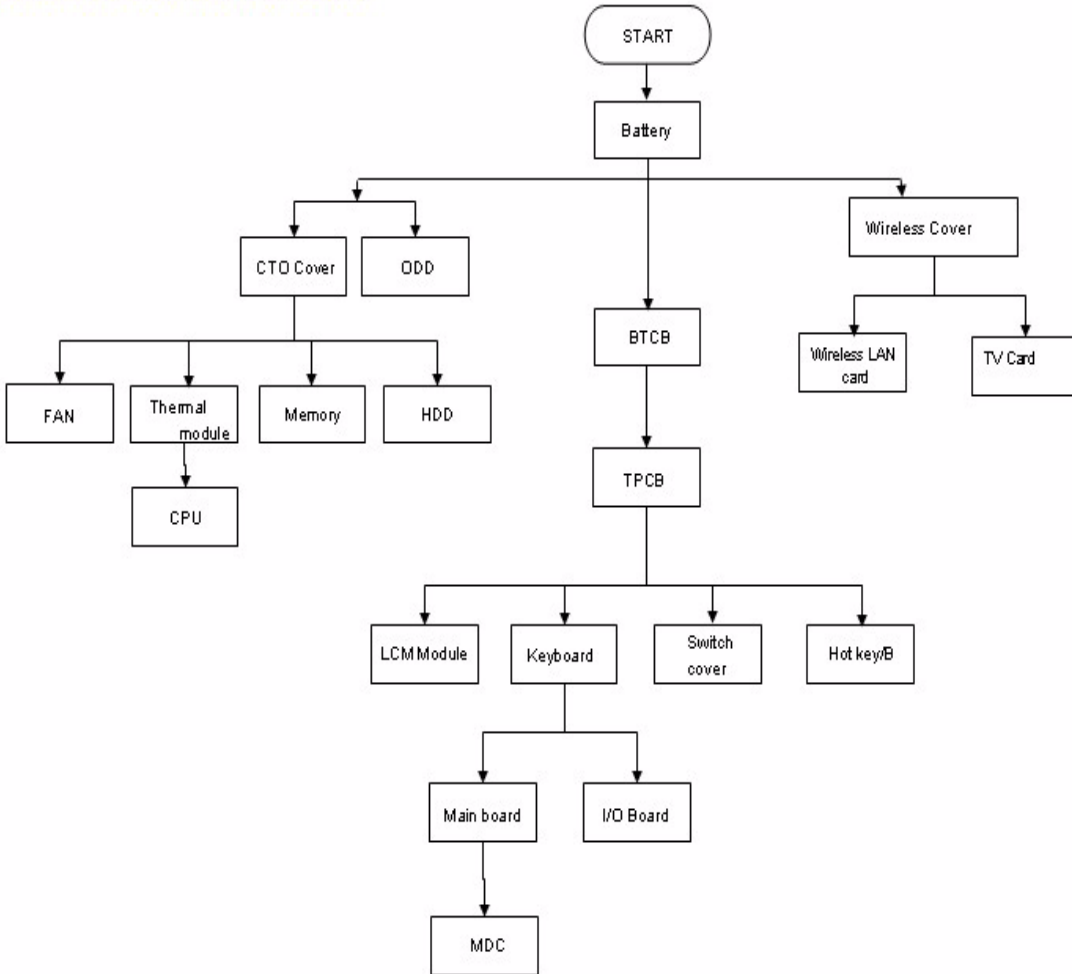

LCM module disassembly flow chart

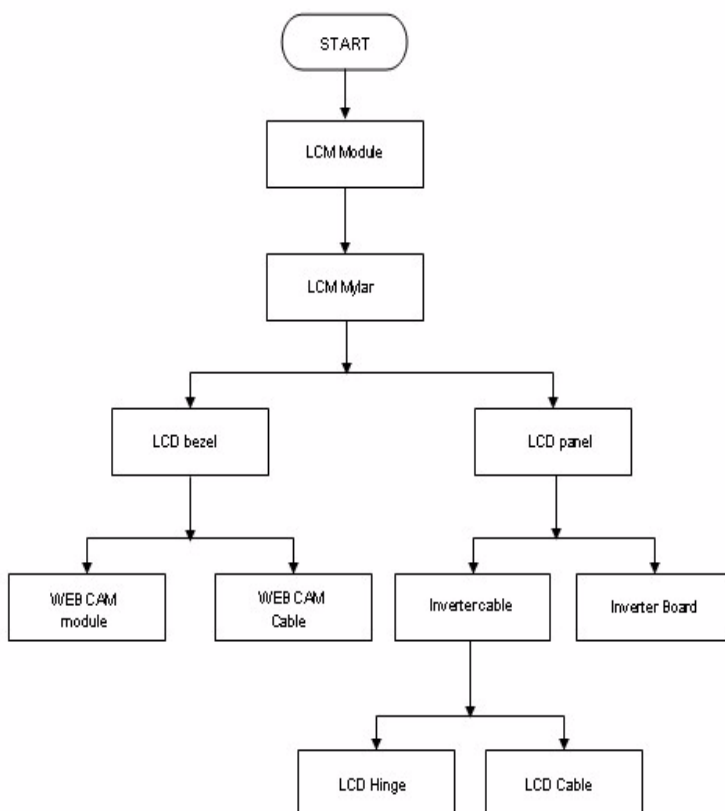

Removing the Battery Pack

1. Release the battery.
2. Slide the battery latch then remove the battery.

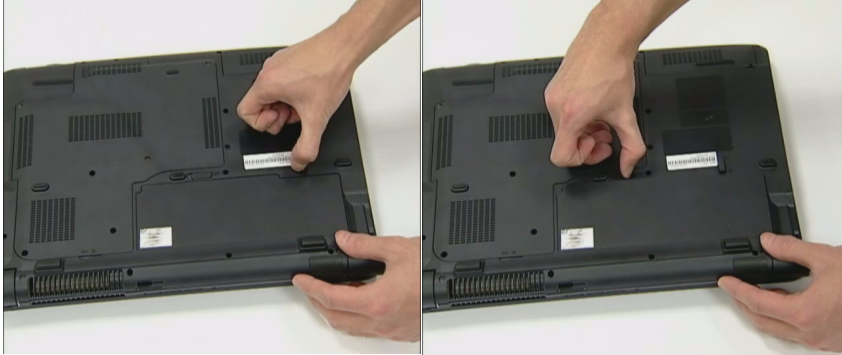

Removing the HDD/Memory Module/Wireless LAN Card/TV Tuner Card/ System Fan/Thermal Modules/CPU

Removing the HDD

1. Remove the six screws fastening the CTO cover
2. Detach the CTO cover from the notebook.

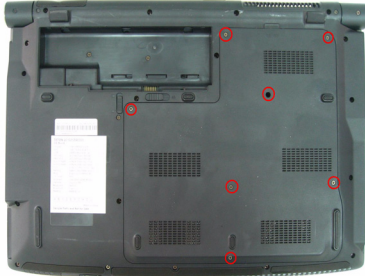

Removing the Wireless Card & RAM Module

3. Remove the wireless antenna and remove the wireless screws then remove the wireless card.
4. Pop out the memory module from the DIMM socket then remove it (If the notebook has two memory modules, then repeat this step).

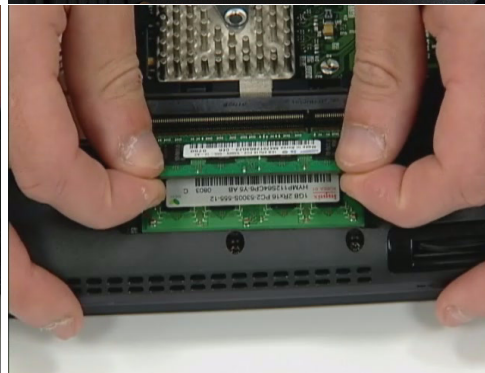
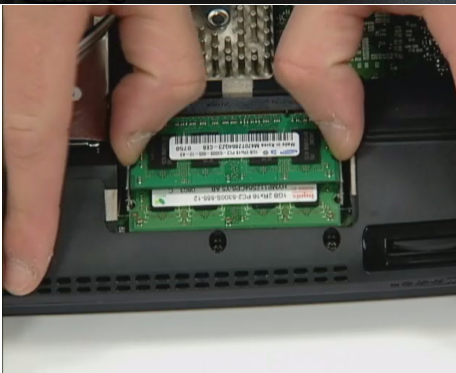

Removing the TV Tuner Card, HDD module and System Fan

5. Disconnect the main and auxiliary antennae from the TV card.
6. Loose two screws from the TV card.
7. Remove the TV card from the machine.

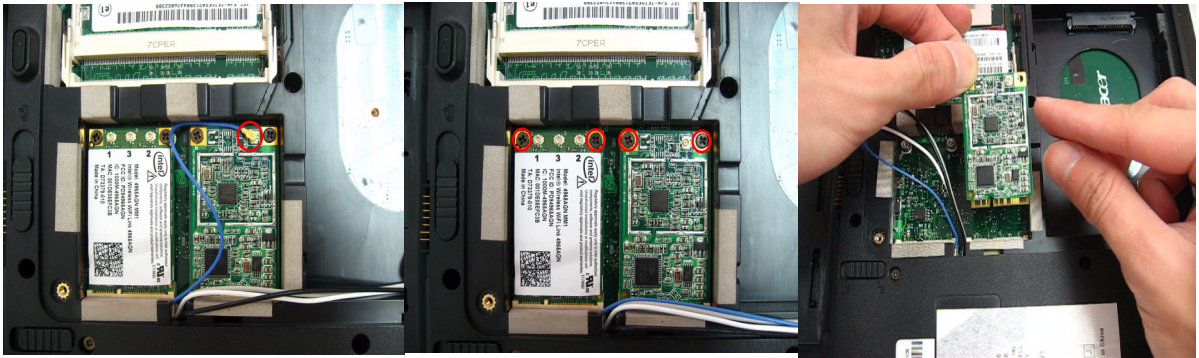

8. Remove HDD module as shown.

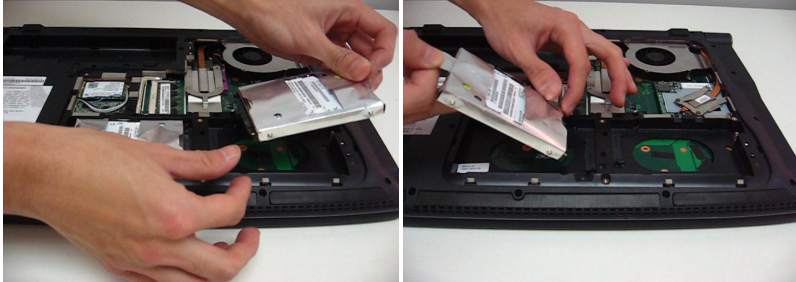

9. Remove FAN cable from the machine.

10. Loose the FAN screw.

11. Take out the system fan from the main unit as shown.

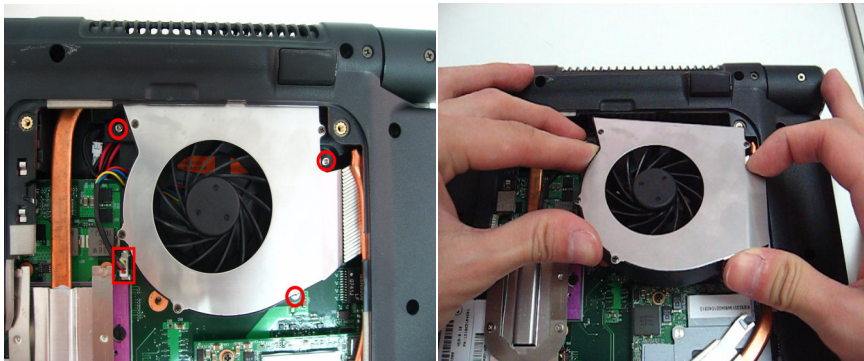

Removing the Thermal Modules and the CPU

12. Remove the two screws holding the finger heatsink.

13. Detach the finger heatsink from the main board.

14. Then take out the CPU heatsink from the main board.

15. Use a flat screwdriver to release the CPU lock (Turn counter clock-wise) then remove the CPU carefully.

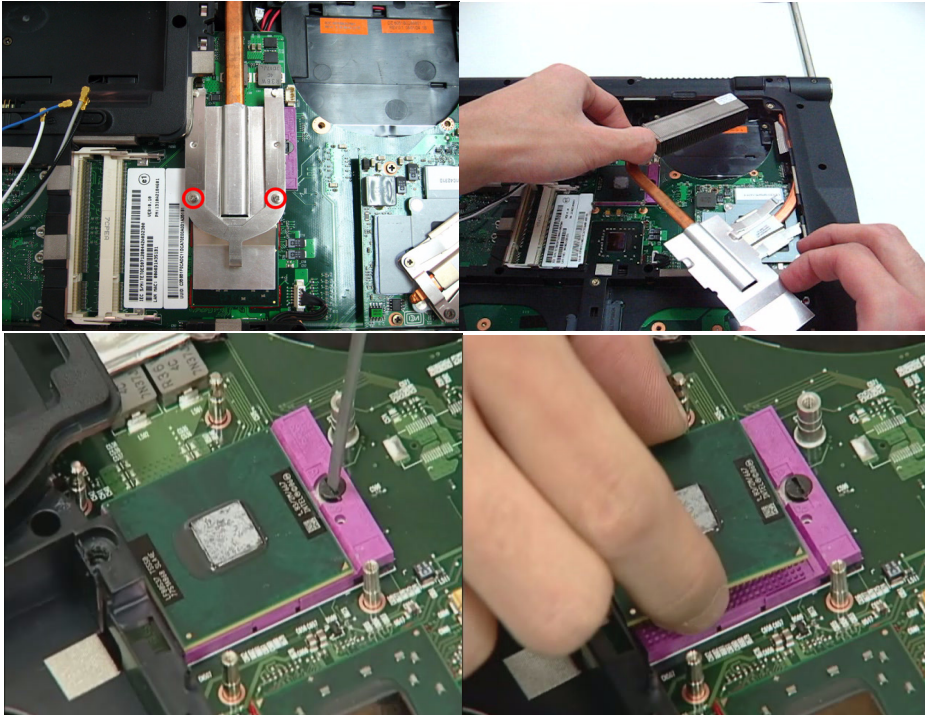

- 16. Remove the Express dummy card.
- 17. Remove the card reader dummy.

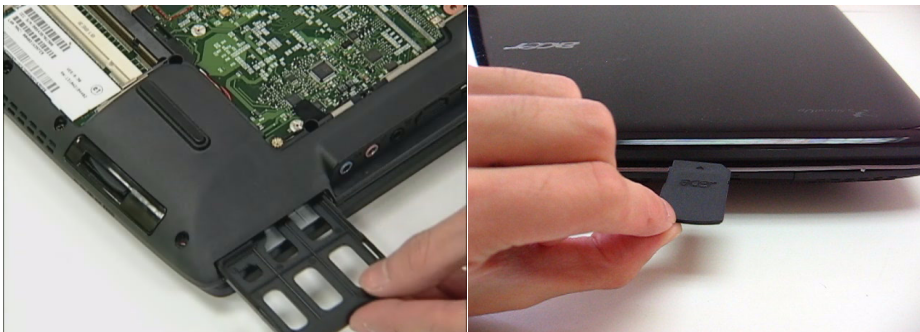

Removing the ODD

- 18. Remove the screw fastening the optical disk drive module on the bottom.

19. Use a tool to push the optical disk drive module outwards and remove the ODD module

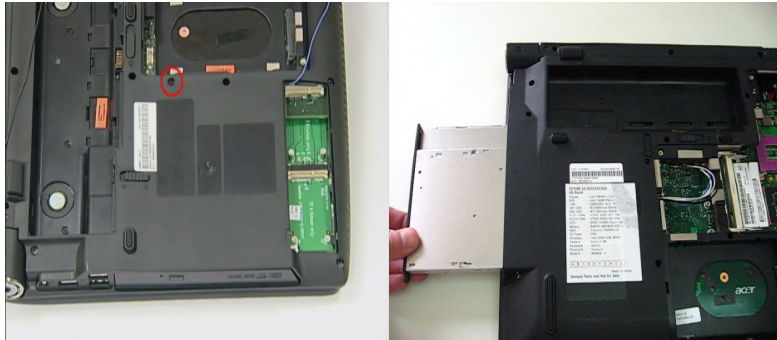

Removing the Hinge cover

- 20. Remove two hinge cover screws.
- 21. Then detach the Hinge cover from both side.

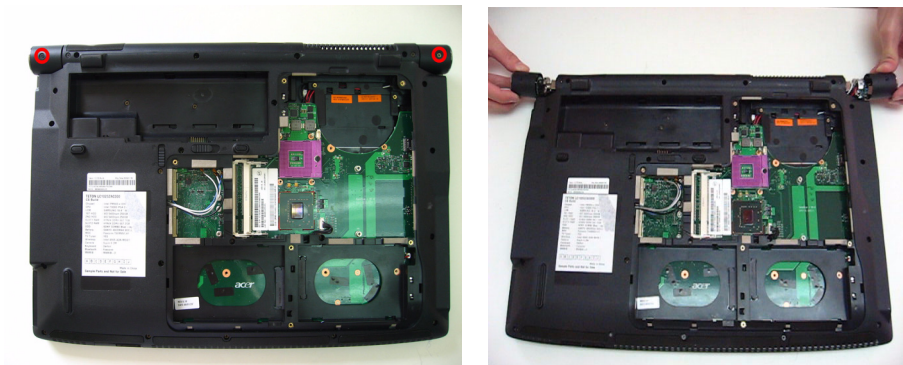

Removing the BTCB screws

- 22. Loose 21 screws from BTCB.



23. Detach Switch cover.

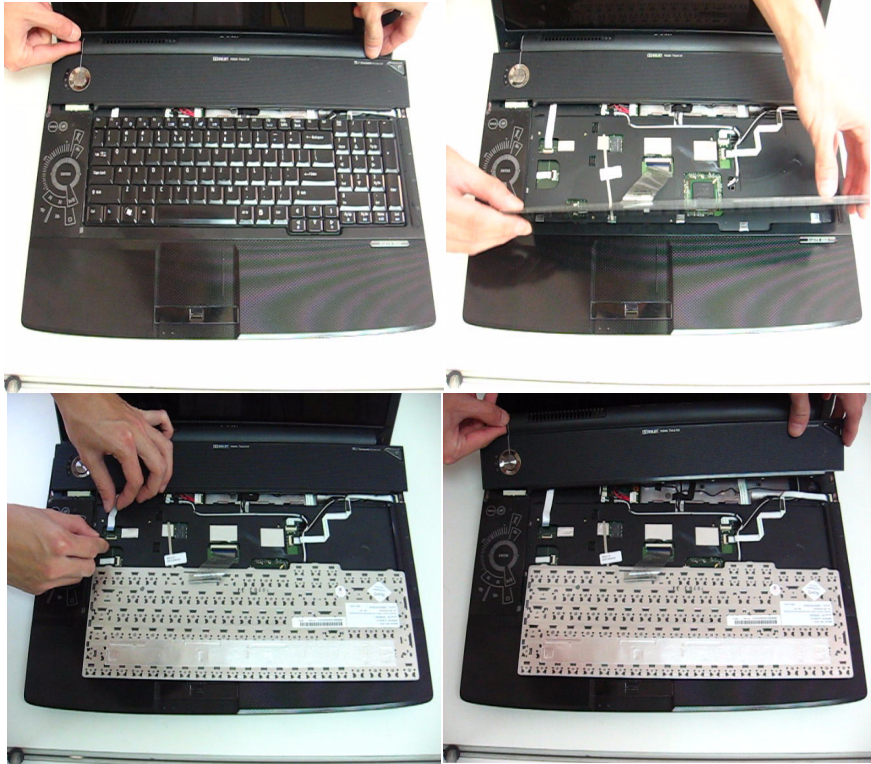

24. Disconnect Media board FFC from the Switch cover

25. Then remove the switch cover from the machine.

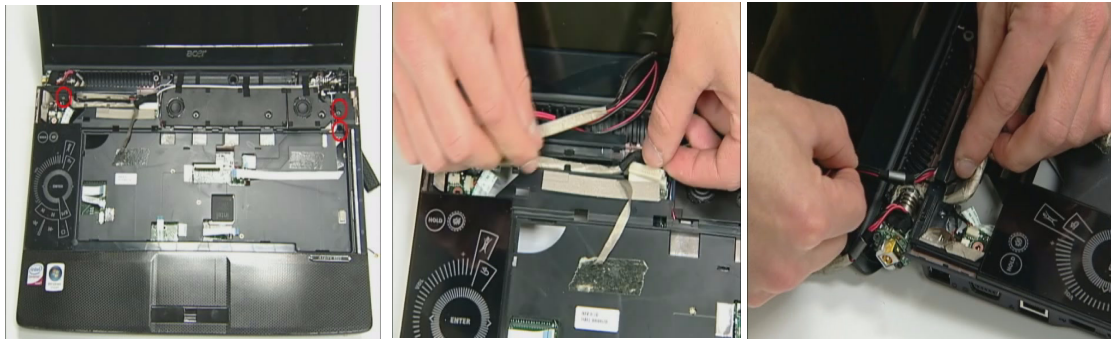

Disassembling the Main Unit

1. Turn over the keyboard as the image shows.
2. Disconnect the Keyboard FFC from the main board
3. Then remove the keyboard from the main unit.

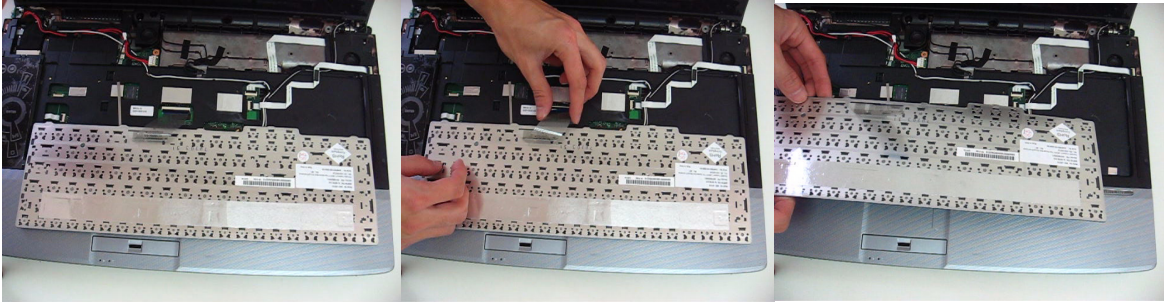

4. Disconnect the FFC from the main board.

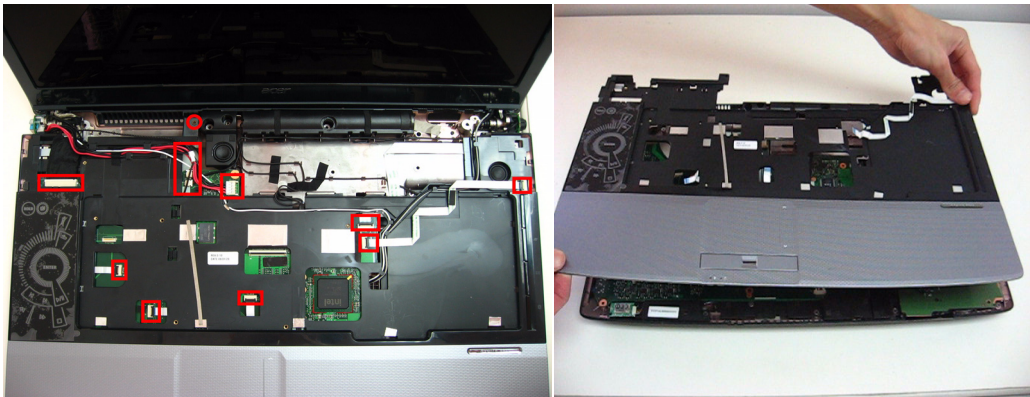

5. Loose One screws from the TPCB.
6. Disconnect the LCM cable.
7. Pull out the Power cable.
8. Pull out the Wireless antenna.
9. Release four TPCB locker then remove the TCB from machine.

Disassembling the LED boards

10. Loose the LED boards four screws.
11. Remove two LED boards from the machine.

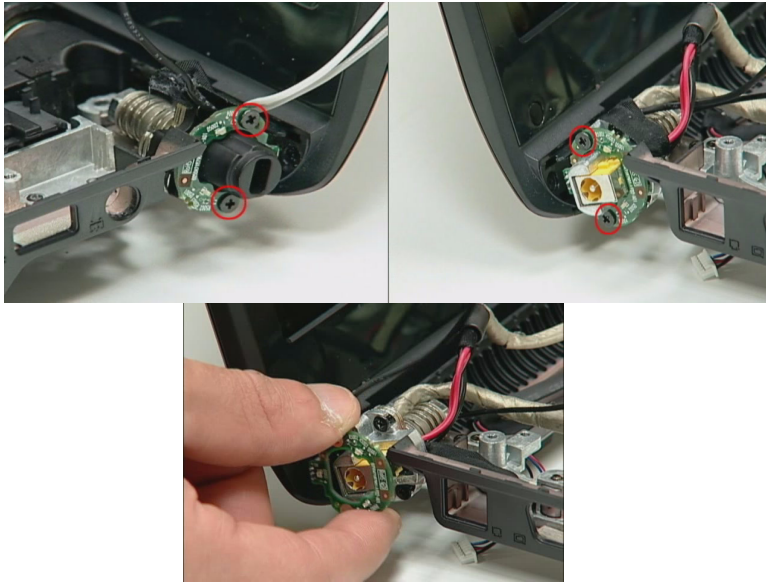

12. Loose four LCM hinge screws.
13. Then remove LCM module from the machine.

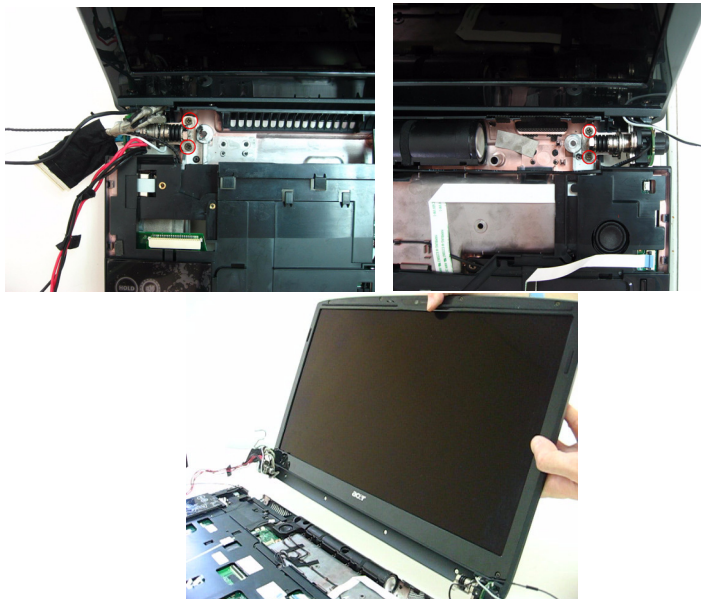

Remove I/O board and Main Board.

14. Remove the daughter board from the machine.

15. Loose two Modem card screws.

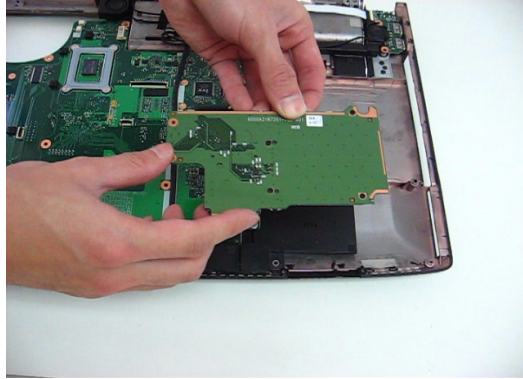

16. Disconnect Modem card cable.

17. Remove Modem card from the M/B.

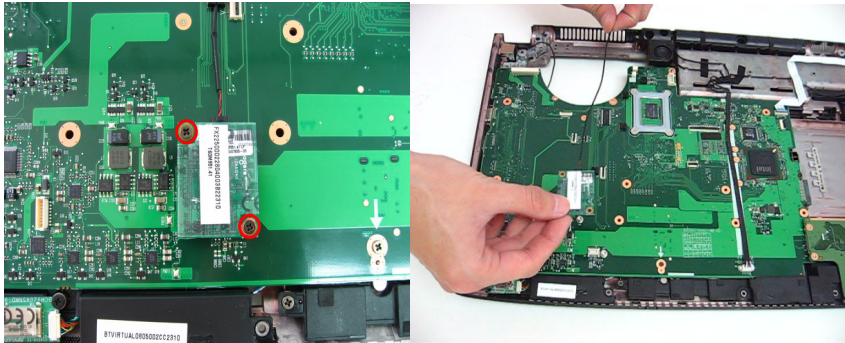

18. Disconnect Speaker cable from the MB and loose the MB screw.

19. Remove M/B from the BTCB.

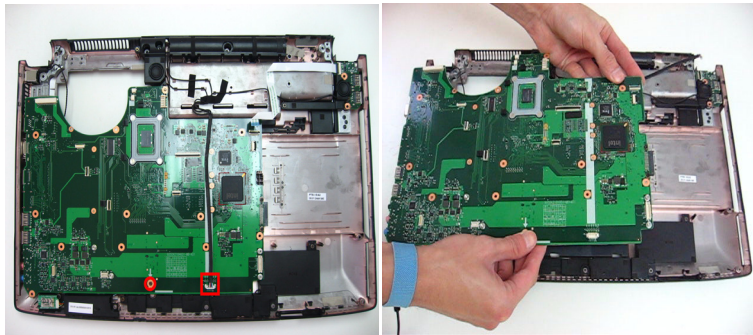

20. Remove RJ11 from the BTCB.

-
21. Remove the USB board from BTCB..

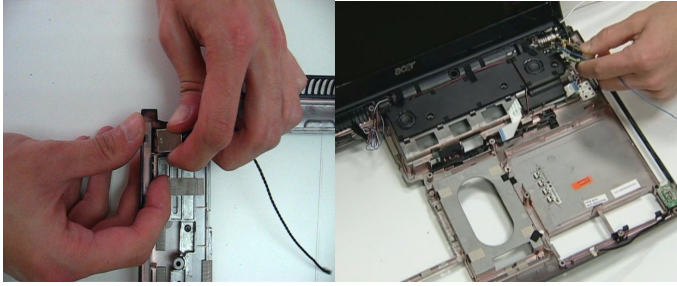

Disassembly LCM module

1. Remove six LCM bezel mylar.
2. Loose 10 LCM bezel screws.
3. Remove LCM bezel.



4. Disconnect Inverter cable and Back LED board cable.
5. Remove Inverter from BTCB..



6. Loose four LCD scrws from the hinge.
7. Disconnect CCD cable.
8. Remove the LCD panel.



9. Loose four LCD hinge screws, then remove two hinges from LCD panel.

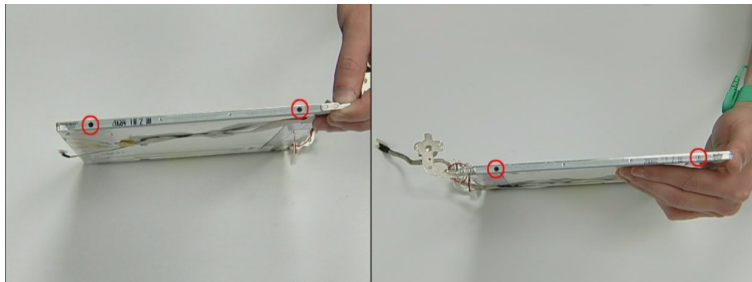

Disassembling the External Modules

Disassembling the HDD Module

1. Remove the four screws holding the HDD (hard disk drive) foil; two on each side.
2. Carefully take out the hard disk drive from the HDD foil.



Disassembling the ODD Module

1. Remove the two screws holding the optical bracket.
2. Then remove the optical bracket from the optical disk drive.



Troubleshooting

Use the following procedure as a guide for computer problems.

NOTE: The diagnostic tests are intended to test only Acer products. Non-Acer products, prototype cards, or modified options can give false errors and invalid system responses.

1. Obtain the failing symptoms in as much detail as possible.
2. Verify the symptoms by attempting to re-create the failure by running the diagnostic test or by repeating the same operation.
3. Use the following table with the verified symptom to determine which page to go to.

Symptoms (Verified)	Go To
Power failure. (The power indicator does not go on or stay on.)	"Power System Check" on page 81.
POST does not complete. No beep or error codes are indicated.	"Power-On Self-Test (POST) Error Message" on page 84 "Undetermined Problems" on page 96
POST detects an error and displayed messages on screen.	"Error Message List" on page 85
Other symptoms (i.e. LCD display problems or others).	"Power-On Self-Test (POST) Error Message" on page 84
Symptoms cannot be re-created (intermittent problems).	Use the customer-reported symptoms and go to "Power-On Self-Test (POST) Error Message" on page 84 "Intermittent Problems" on page 95 "Undetermined Problems" on page 96

System Check Procedures

External Diskette Drive Check

Do the following to isolate the problem to a controller, driver, or diskette. A write-enabled, diagnostic diskette is required.

NOTE: Make sure that the diskette does not have more than one label attached to it. Multiple labels can cause damage to the drive or cause the drive to fail.

Do the following to select the test device.

1. Boot from the diagnostics diskette and start the diagnostics program.
2. See if FDD Test is passed as the program runs to FDD Test.
3. Follow the instructions in the message window.

If an error occurs with the internal diskette drive, reconnect the diskette connector on the system board.

If the error still remains:

1. Reconnect the external diskette drive/DVD-ROM module.
2. Replace the external diskette drive/CD-ROM module.
3. Replace the main board.

External CD-ROM Drive Check

Do the following to isolate the problem to a controller, drive, or CD-ROM. Make sure that the CD-ROM does not have any label attached to it. The label can cause damage to the drive or can cause the drive to fail.

Do the following to select the test device:

1. Boot from the diagnostics diskette and start the diagnostics program.
2. See if CD-ROM Test is passed when the program runs to CD-ROM Test.
3. Follow the instructions in the message window.

If an error occurs, reconnect the connector on the System board. If the error still remains:

1. Reconnect the external diskette drive/CD-ROM module.
2. Replace the external diskette drive/CD-ROM module.
3. Replace the main board.

Keyboard or Auxiliary Input Device Check

Remove the external keyboard if the internal keyboard is to be tested.

If the internal keyboard does not work or an unexpected character appears, make sure that the flexible cable extending from the keyboard is correctly seated in the connector on the system board.

If the keyboard cable connection is correct, run the Keyboard Test.

If the tests detect a keyboard problem, do the following one at a time to correct the problem. Do not replace a non-defective FRU:

1. Reconnect the keyboard cables.
2. Replace the keyboard.
3. Replace the main board.

The following auxiliary input devices are supported by this computer:

- q Numeric keypad
- q External keyboard

If any of these devices do not work, reconnect the cable connector and repeat the failing operation.

Memory check

Memory errors might stop system operations, show error messages on the screen, or hang the system.

1. Boot from the diagnostics diskette and start the doagmpstotics program (please refer to main board).
2. Go to the diagnostic memory in the test items.
3. Press F2 in the test items.
4. Follow the instructions in the message window.

NOTE: Make sure that the DIMM is fully installed into the connector. A loose connection can cause an error.

Power System Check

To verify the symptom of the problem, power on the computer using each of the following power sources:

1. Remove the battery pack.
2. Connect the power adapter and check that power is supplied.
3. Disconnect the power adapter and install the charged battery pack; then check that power is supplied by the battery pack.

If you suspect a power problem, see the appropriate power supply check in the following list:

“Check the Power Adapter” on page 82

“Check the Battery Pack” on page 83

Check the Power Adapter

Unplug the power adapter cable from the computer and measure the output voltage at the plug of the power adapter cable. See the following figure

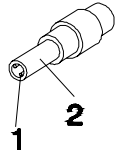

Pin 1: +19 to +20.5V
Pin 2: 0V, Ground

1. If the voltage is not correct, replace the power adapter.
2. If the voltage is within the range, do the following:

Replace the System board.

If the problem is not corrected, see “Undetermined Problems” on page 96.

If the voltage is not correct, go to the next step.

NOTE: An audible noise from the power adapter does not always indicate a defect.

3. If the power-on indicator does not light up, check the power cord of the power adapter for correct continuity and installation.
4. If the operational charge does not work, see “Check the Battery Pack” on page 83.

Check the Battery Pack

To check the battery pack, do the following:

From Software:

1. Check out the Power Management in control Panel
2. In Power Meter, confirm that if the parameters shown in the screen for Current Power Source and Total Battery Power Remaining are correct.
3. Repeat the steps 1 and 2, for both battery and adapter.
4. This helps you identify first the problem is on recharging or discharging.

From Hardware:

1. Power off the computer.
2. Remove the battery pack and measure the voltage between battery terminals 1(+) and 6(ground). See the following figure

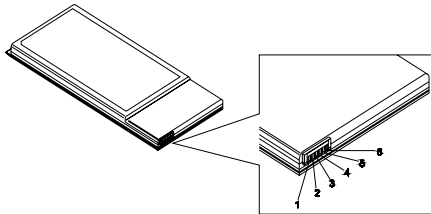

3. If the voltage is still less than 7.5 Vdc after recharging, replace the battery.

To check the battery charge operation, use a discharged battery pack or a battery pack that has less than 50% of the total power remaining when installed in the computer.

If the battery status indicator does not light up, remove the battery pack and let it return to room temperature. Re-install the battery pack.

If the charge indicator still does not light up, replace the battery pack. If the charge indicator still does not light up, replace the DC/DC charger board.

Touchpad Check

If the touchpad doesn't work, do the following actions one at a time to correct the problem. Do not replace a non-defective FRU:

1. Reconnect the touchpad cables.
2. Replace the touchpad.
3. Replace the system board.

After you use the touchpad, the pointer drifts on the screen for a short time. This self-acting pointer movement can occur when a slight, steady pressure is applied to the touchpad pointer. This symptom is not a hardware problem. No service actions are necessary if the pointer movement stops in a short period of time.

Power-On Self-Test (POST) Error Message

The POST error message index lists the error message and their possible causes. The most likely cause is listed first.

NOTE: Perform the FRU replacement or actions in the sequence shown in FRU/Action column, if the FRU replacement does not solve the problem, put the original part back in the computer. Do not replace a non-defective FRU.

This index can also help you determine the next possible FRU to be replaced when servicing a computer.

If the symptom is not listed, see “Undetermined Problems” on page 96.

The following lists the error messages that the BIOS displays on the screen and the error symptoms classified by function.

NOTE: Most of the error messages occur during POST. Some of them display information about a hardware device, e.g., the amount of memory installed. Others may indicate a problem with a device, such as the way it has been configured.

NOTE: If the system fails after you make changes in the BIOS Setup Utility menus, reset the computer, enter Setup and install Setup defaults or correct the error.

Index of Error Messages

Error Code List

Error Codes	Error Messages
006	Equipment Configuration Error Causes: 1. CPU BIOS Update Code Mismatch 2. IDE Primary Channel Master Drive Error (The causes will be shown before "Equipment Configuration Error")
010	Memory Error at xxxx:xxxx:xxxxh (R:xxxxh, W:xxxxh)
070	Real Time Clock Error
071	CMOS Battery Bad
072	CMOS Checksum Error
110	System disabled. Incorrect password is specified.
<No error code>	Battery critical LOW In this situation BIOS will issue 4 short beeps then shut down system, no message will show.
<No error code>	Thermal critical High In this situation BIOS will shut down system, not show message.

Error Message List

Error Messages	FRU/Action in Sequence
Failure Fixed Disk	Reconnect hard disk drive connector. "Load Default Settings" in BIOS Setup Utility. Hard disk drive System board
Stuck Key	see "Keyboard or Auxiliary Input Device Check" on page 80.
Keyboard error	see "Keyboard or Auxiliary Input Device Check" on page 80.
Keyboard Controller Failed	see "Keyboard or Auxiliary Input Device Check" on page 80.
Keyboard locked - Unlock key switch	Unlock external keyboard
Monitor type does not match CMOS - Run Setup	Run "Load Default Settings" in BIOS Setup Utility.
Shadow RAM Failed at offset: nnnn	BIOS ROM System board
System RAM Failed at offset: nnnn	DIMM System board
Extended RAM Failed at offset: nnnn	DIMM System board
System battery is dead - Replace and run Setup	Replace RTC battery and Run BIOS Setup Utility to reconfigure system time, then reboot system.
System CMOS checksum bad - Default configuration used	RTC battery Run BIOS Setup Utility to reconfigure system time, then reboot system.
System timer error	RTC battery Run BIOS Setup Utility to reconfigure system time, then reboot system. System board

Error Message List

Error Messages	FRU/Action in Sequence
Real time clock error	RTC battery Run BIOS Setup Utility to reconfigure system time, then reboot system. System board
Previous boot incomplete - Default configuration used	Run "Load Default Settings" in BIOS Setup Utility. RTC battery System board
Memory size found by POST differed from CMOS	Run "Load Default Settings" in BIOS Setup Utility. DIMM System board
Diskette drive A error	Check the drive is defined with the proper diskette type in BIOS Setup Utility See "External Diskette Drive Check" on page 80.
Incorrect Drive A type - run SETUP	Check the drive is defined with the proper diskette type in BIOS Setup Utility
System cache error - Cache disabled	System board
CPU ID:	System board
DMA Test Failed	DIMM System board
Software NMI Failed	DIMM System board
Fail-Safe Timer NMI Failed	DIMM System board
Device Address Conflict	Run "Load Default Settings" in BIOS Setup Utility. RTC battery System board
Allocation Error for device	Run "Load Default Settings" in BIOS Setup Utility. RTC battery System board
Failing Bits: nnnn	DIMM BIOS ROM System board
Fixed Disk n	None
Invalid System Configuration Data	BIOS ROM System board
I/O device IRQ conflict	Run "Load Default Settings" in BIOS Setup Utility. RTC battery System board
Operating system not found	Enter Setup and see if fixed disk and drive A: are properly identified. Diskette drive Hard disk drive System board

Error Message List

No beep Error Messages	FRU/Action in Sequence
No beep, power-on indicator turns off and LCD is blank.	Power source (battery pack and power adapter). See "Power System Check" on page 81.. Ensure every connector is connected tightly and correctly. Reconnect the DIMM. LED board. System board.
No beep, power-on indicator turns on and LCD is blank.	Power source (battery pack and power adapter). See "Power System Check" on page 81.. Reconnect the LCD connector Hard disk drive LCD inverter ID LCD cable LCD Inverter LCD System board
No beep, power-on indicator turns on and LCD is blank. But you can see POST on an external CRT.	Reconnect the LCD connectors. LCD inverter ID LCD cable LCD inverter LCD System board
No beep, power-on indicator turns on and a blinking cursor shown on LCD during POST.	Ensure every connector is connected tightly and correctly. System board
No beep during POST but system runs correctly.	Speaker System board

Phoenix BIOS Beep Codes

Code	Beeps	POST Routine Description
02h		Verify Real Mode
03h		Disable Non-Maskable Interrupt (NMI)
04h		Get CPU type
06h		Initialize system hardware
08h		Initialize chipset with initial POST values
09h		Set IN POST flag
0Ah		Initialize CPU registers
0Bh		Enable CPU cache
0Ch		Initialize caches to initial POST values
0Eh		Initialize I/O component
0Fh		Initialize the local bus IDE
10h		Initialize Power Management
11h		Load alternate registers with initial POST values
12h		Restore CPU control word during warm boot
13h		Initialize PCI Bus Mastering devices
14h		Initialize keyboard controller
16h	1-2-2-3	BIOS ROM checksum
17h		Initialize cache before memory autosize
18h		8254 timer initialization
1Ah		8237 DMA controller initialization
1Ch		Reset Programmable Interrupt Controller
20h	1-3-1-1	Test DRAM refresh
22h	1-3-1-3	Test 8742 Keyboard Controller
24h		Set ES segment register to 4 GB
26h		Enable A20 line
28h		Autosize DRAM
29h		Initialize POST Memory Manager
2Ah		Clear 215 KB base RAM
2Ch	1-3-4-1	RAM failure on address line xxxx
2Eh	1-3-4-3	RAM failure on data bits xxxx of low byte of memory bus
2Fh		Enable cache before system BIOS shadow
30h	1-4-1-1	RAM failure on data bits xxxx of high byte of memory bus
32h		Test CPU bus-clock frequency
33h		Initialize Phoenix Dispatch Manager
36h		Warm start shut down
38h		Shadow system BIOS ROM
3Ah		Autosize cache
3Ch		Advanced configuration of chipset registers
3Dh		Load alternate registers with CMOS values
42h		Initialize interrupt vectors
45h		POST device initialization

Code	Beeps	POST Routine Description
46h	2-1-2-3	Check ROM copyright notice
48h		Check video configuration against CMOS
49h		Initialize PCI bus and devices
4Ah		Initialize all video adapters in system
4Bh		QuietBoot start (optional)
4Ch		Shadow video BIOS ROM
4Eh		Display BIOS copyright notice
50h		Display CPU type and speed
51h		Initialize EISA board
52h		Test keyboard
54h		Set key click if enabled
58h	2-2-3-1	Test for unexpected interrupts
59h		Initialize POST display service
5Ah		Display prompt "Press F2 to enter SETUP"
5Bh		Disable CPU cache
5Ch		Test RAM between 512 and 640 KB
60h		Test extended memory
62h		Test extended memory address lines
64h		Jump to User Patch1
66h		Configure advanced cache registers
67h		Initialize Multi Processor APIC
68h		Enable external and CPU caches
69h		Setup System Management Mode (SMM) area
6Ah		Display external L2 cache size
6Bh		Load custom defaults (optional)
6Ch		Display shadow-area message
6Eh		Display possible high address for UMB recovery
70h		Display error messages
72h		Check for configuration errors
76h		Check for keyboard errors
7Ch		Set up hardware interrupt vectors
7Eh		Initialize coprocessor if present
80h		Disable onboard Super I/O ports and IRQs
81h		Late POST device initialization
82h		Detect and install external RS232 ports
83h		Configure non-MCD IDE controllers
84h		Detect and install external parallel ports
85h		Initialize PC-compatible PnP ISA devices
86h		Re-initialize onboard I/O ports
87h		Configure Motherboard Configurable Devices (optional)
88h		Initialize BIOS Area
89h		Enable Non-Maskable Interrupts (NMIs)
8Ah		Initialize Extended BIOS Data Area
8Bh		Test and initialize PS/2 mouse

Code	Beeps	POST Routine Description
8Ch		Initialize floppy controller
8Fh		Determine number of ATA drives (optional)
90h		Initialize hard-disk controllers
91h		Initialize local-bus hard-disk controllers
92h		Jump to UserPatch2
93h		Build MPTABLE for multi-processor boards
95h		Install CD ROM for boot
96h		Clear huge ES segment register
97h		Fixup Multi Processor table
98h	1-2	Search for option ROMs. One long, two short beeps on checksum failure.
99h		Check for SMART drive (optional)
9Ah		Shadow option ROMs
9Ch		Set up Power Management
9Dh		Initialize security engine (optional)
9Eh		Enable hardware interrupts
9Fh		Determine number of ATA and SCSI drives
A0h		Set time of day
A2h		Check key lock
A4h		Initialize Typematic rate
A8h		Erase F2 prompt
AAh		Scan for F2 key stroke
ACh		Enter SETUP
AEh		Clear Boot flag
B0h		Check for errors
B2h		POST done- prepare to boot operating system
B4h	1	One short beep before boot
B5h		Terminate QuietBoot (optional)
B6h		Check password (optional)
B9h		Prepare Boot
BAh		Initialize DMI parameters
BBh		Initialize PnP Option ROMs
BCh		Clear parity checkers
BDh		Display MultiBoot menu
BEh		Clear screen (optional)
BFh		Check virus and backup reminders
C0h		Try to boot with INT 19
C1h		Initialize POST Error Manager (PEM)
C2h		Initialize error logging
C3h		Initialize error display function
C4h		Initialize system error handler
C5h		PnPnd dual CMOS (optional)
C6h		Initialize notebook docking (optional)
C7h		Initialize notebook docking late
C8h		Force check (optional)
C9h		Extended checksum (optional)

Code	Beeps	POST Routine Description
D2h		Unknown interrupt

Code	Beeps	POST Routine Description
E0h		Initialize the chipset
E1h		Initialize the bridge
E2h		Initialize the CPU
E3h		Initialize the system timer
E4h		Initialize system I/O
E5h		Check force recovery boot
E6h		Checksum BIOS ROM
E7h		Go to BIOS
E8h		Set Huge Segment
E9h		Initialize Multi Processor
EAh		Initialize OEM special code
EBh		Initialize PIC and DMA
ECh		Initialize Memory type
EDh		Initialize Memory size
EEh		Shadow Boot Block
EFh		System memory test
F0h		Initialize interrupt vectors
F1h		Initialize Run Time Clock
F2h		Initialize video
F3h		Initialize System Management Mode
F4h	1	Output one beep before boot
F5h		Boot to Mini DOS
F6h		Clear Huge Segment
F7h		Boot to Full DOS

Index of Symptom-to-FRU Error Message

LCD-Related Symptoms

Symptom / Error	Action in Sequence
LCD backlight doesn't work LCD is too dark LCD brightness cannot be adjusted LCD contrast cannot be adjusted	Enter BIOS Utility to execute "Load Setup Default Settings", then reboot system. Reconnect the LCD connectors. Keyboard (if contrast and brightness function key doesn't work). LCD inverter ID LCD cable LCD inverter LCD System board
Unreadable LCD screen Missing pels in characters Abnormal screen Wrong color displayed	Reconnect the LCD connector LCD inverter ID LCD cable LCD inverter LCD System board
LCD has extra horizontal or vertical lines displayed.	LCD inverter ID LCD inverter LCD cable LCD System board

Indicator-Related Symptoms

Symptom / Error	Action in Sequence
Indicator incorrectly remains off or on, but system runs correctly	Reconnect the inverter board Inverter board System board

Power-Related Symptoms

Symptom / Error	Action in Sequence
Power shuts down during operation	Power source (battery pack and power adapter). See "Power System Check" on page 81. Battery pack Power adapter Hard drive & battery connection board System board
The system doesn't power-on.	Power source (battery pack and power adapter). See "Power System Check" on page 81. Battery pack Power adapter Hard drive & battery connection board System board
The system doesn't power-off.	Power source (battery pack and power adapter). See "Power System Check" on page 81. Hold and press the power switch for more than 4 seconds. System board

Power-Related Symptoms

Symptom / Error	Action in Sequence
Battery can't be charged	See "Check the Battery Pack" on page 83. Battery pack System board

PCMCIA-Related Symptoms

Symptom / Error	Action in Sequence
System cannot detect the PC Card (PCMCIA)	PCMCIA slot assembly System board
PCMCIA slot pin is damaged.	PCMCIA slot assembly

Memory-Related Symptoms

Symptom / Error	Action in Sequence
Memory count (size) appears different from actual size.	Enter BIOS Setup Utility to execute "Load Default Settings, then reboot system. DIMM System board

Speaker-Related Symptoms

Symptom / Error	Action in Sequence
In Windows, multimedia programs, no sound comes from the computer.	Audio driver Speaker System board
Internal speakers make noise or emit no sound.	Speaker System board

Power Management-Related Symptoms

Symptom / Error	Action in Sequence
The system will not enter hibernation	See "Save to Disk (S4)" on page 45. Keyboard (if control is from the keyboard) Hard disk drive System board
The system doesn't enter hibernation mode and four short beeps every minute.	Press Fn+ O and see if the computer enters hibernation mode. Touchpad Keyboard Hard disk connection board Hard disk drive System board
The system doesn't enter standby mode after closing the LCD	See "Save to Disk (S4)" on page 45. LCD cover switch System board
The system doesn't resume from hibernation mode.	See "Save to Disk (S4)" on page 45. Hard disk connection board Hard disk drive System board
The system doesn't resume from standby mode after opening the LCD.	See "Save to Disk (S4)" on page 45. LCD cover switch System board

Power Management-Related Symptoms

Symptom / Error	Action in Sequence
Battery fuel gauge in Windows doesn't go higher than 90%.	Remove battery pack and let it cool for 2 hours. Refresh battery (continue use battery until power off, then charge battery). Battery pack System board
System hangs intermittently.	Reconnect hard disk/CD-ROM drives. Hard disk connection board System board

Peripheral-Related Symptoms

Symptom / Error	Action in Sequence
System configuration does not match the installed devices.	Enter BIOS Setup Utility to execute "Load Default Settings", then reboot system. Reconnect hard disk/CD-ROM/diskette drives.
External display does not work correctly.	Press Fn+F5, LCD/CRT/Both display switching System board
USB does not work correctly	System board
Print problems.	Ensure the "Parallel Port" in the "Onboard Devices Configuration" of BIOS Setup Utility is set to Enabled. Onboard Devices Configuration Run printer self-test. Printer driver Printer cable Printer System Board
Serial or parallel port device problems.	Ensure the "Serial Port" in the Devices Configuration" of BIOS Setup Utility is set to Enabled. Device driver Device cable Device System board

Keyboard/Touchpad-Related Symptoms

Symptom / Error	Action in Sequence
Keyboard (one or more keys) does not work.	Reconnect the keyboard cable. Keyboard System board
Touchpad does not work.	Reconnect touchpad cable. Touchpad board System board

Modem-Related Symptoms

Symptom / Error	Action in Sequence
Internal modem does not work correctly.	Modem phone port modem combo board System board

NOTE: If you cannot find a symptom or an error in this list and the problem remains, see "Undetermined Problems" on page 96.

Intermittent Problems

Intermittent system hang problems can be caused by a variety of reasons that have nothing to do with a hardware defect, such as: cosmic radiation, electrostatic discharge, or software errors. FRU replacement should be considered only when a recurring problem exists.

When analyzing an intermittent problem, do the following:

1. Run the advanced diagnostic test for the system board in loop mode at least 10 times.
2. If no error is detected, do not replace any FRU.
3. If any error is detected, replace the FRU. Rerun the test to verify that there are no more errors.

Undetermined Problems

The diagnostic problems does not identify which adapter or device failed, which installed devices are incorrect, whether a short circuit is suspected, or whether the system is inoperative.

Follow these procedures to isolate the failing FRU (do not isolate non-defective FRU).

NOTE: Verify that all attached devices are supported by the computer.

NOTE: Verify that the power supply being used at the time of the failure is operating correctly. (See "Power System Check" on page 81.):

1. Power-off the computer.
2. Visually check them for damage. If any problems are found, replace the FRU.
3. Remove or disconnect all of the following devices:
 - Non-Acer devices
 - Printer, mouse, and other external devices
 - Battery pack
 - Hard disk drive
 - DIMM
 - CD-ROM/Diskette drive Module
 - PC Cards
4. Power-on the computer.
5. Determine if the problem has changed.
6. If the problem does not recur, reconnect the removed devices one at a time until you find the failing FRU.
7. If the problem remains, replace the following FRU one at a time. Do not replace a non-defective FRU:
 - System board
 - LCD assembly

Jumper and Connector Locations

Top View

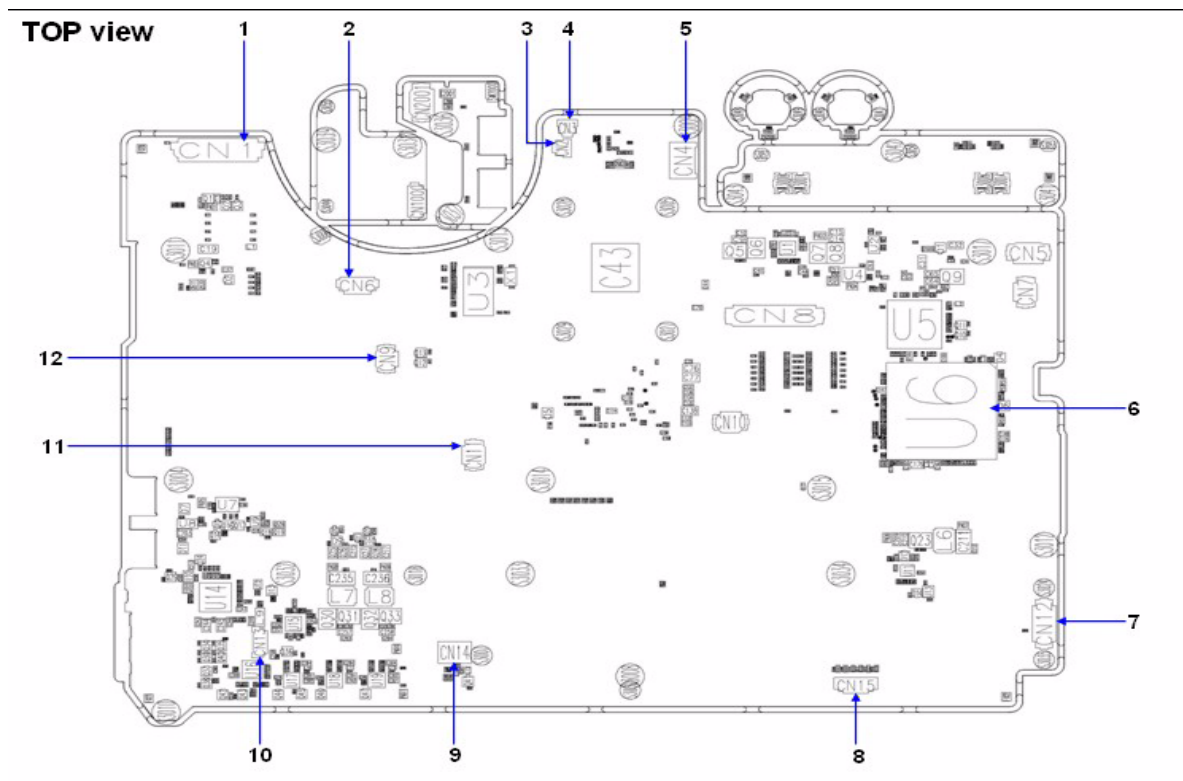

AS8920 M/B layout and connector location TOP view		
No.	Name	Description
1	CN1	LCM Cable CNTR
2	CN6	Power Board FFC CNTR
3	CN2	LED Board Cable CNTR
4	CN3	LED Board Cable CNTR
5	CN4	Power cable CNTR
6	U6	South Bridge
7	CN12	I/O Board CNTR
8	CN15	Speaker cable CNTR
9	CN14	MDC CNTR
10	CN13	BT Cable CNTR
11	CN11	Touch Pad FFC CNTR
12	CN9	Media consle Board CNTR

Bottom View

Bottom view

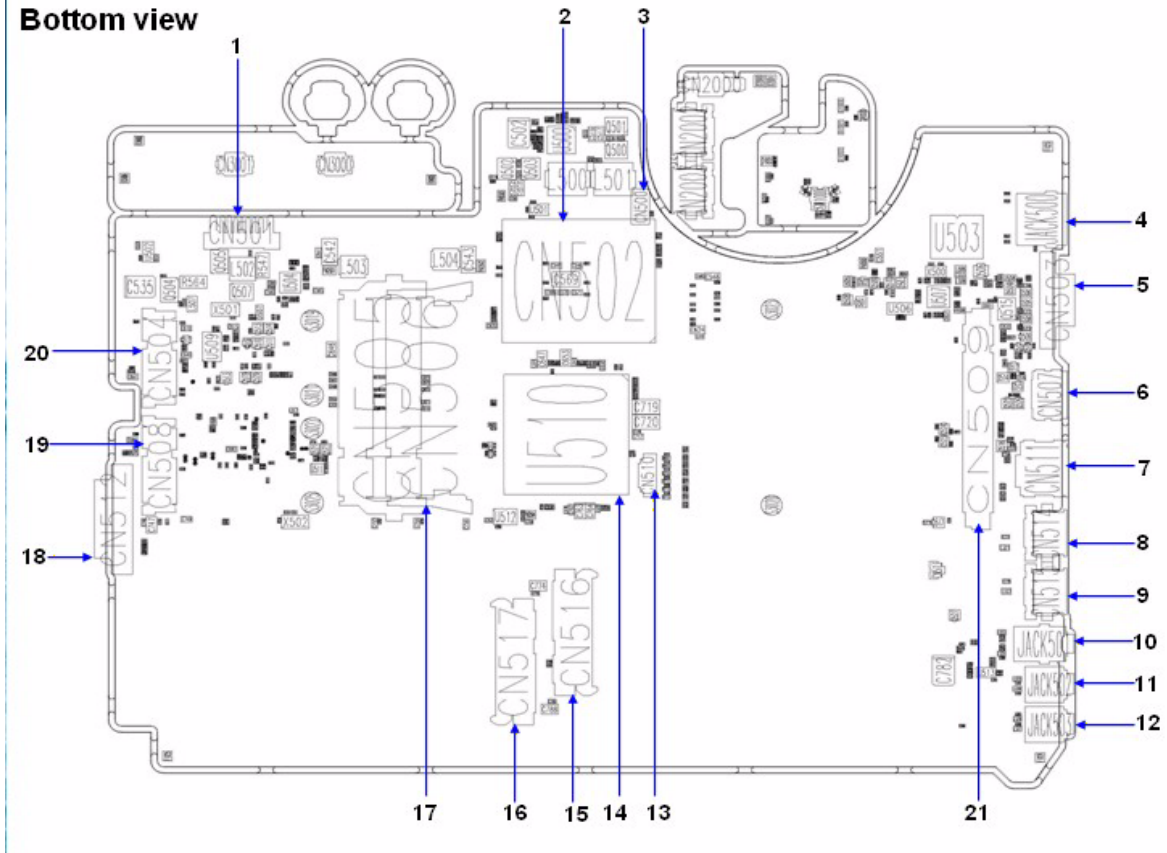

Bottom view		
No.	Name	Description
1	CN501	Battery CNTR
2	CN502	CPU Socket
3	CN500	FAN Cable CNTR
4	Jack500	RJ45
5	CN503	VGA Port
6	CN507	HDMI Port
7	CN511	HDMI Port
8	CN514	USB Port
9	CN515	USB Port
10	Jack501	SPDIF
11	Jack502	MIC jack
12	Jack503	Line in jack
13	CN510	Speaker Cable CNTR
14	U510	North Bridge
15	CN516	HDD socket
16	CN517	HDD socket
17	CN505/506	DIMM Socket
18	CN512	ODD CNTR
19	CN508	PCI-E socket
20	CN504	PCI-E socket
21	CN509	VGA Card Socket

FRU (Field Replaceable Unit) List

This chapter gives you the FRU (Field Replaceable Unit) listing in global configurations of Aspire 8920. Refer to this chapter whenever ordering for parts to repair or for RMA (Return Merchandise Authorization).

Please note that WHEN ORDERING FRU PARTS, you should check the most up-to-date information available on your regional web or channel. For whatever reasons a part number change is made, it will not be noted on the printed Service Guide. For ACER AUTHORIZED SERVICE PROVIDERS, your Acer office may have a DIFFERENT part number code from those given in the FRU list of this printed Service Guide. You MUST use the local FRU list provided by your regional Acer office to order FRU parts for repair and service of customer machines.

NOTE: To scrap or to return the defective parts, you should follow the local government ordinance or regulations on how to dispose it properly, or follow the rules set by your regional Acer office on how to return it.

Aspire 8920 Exploded Diagram

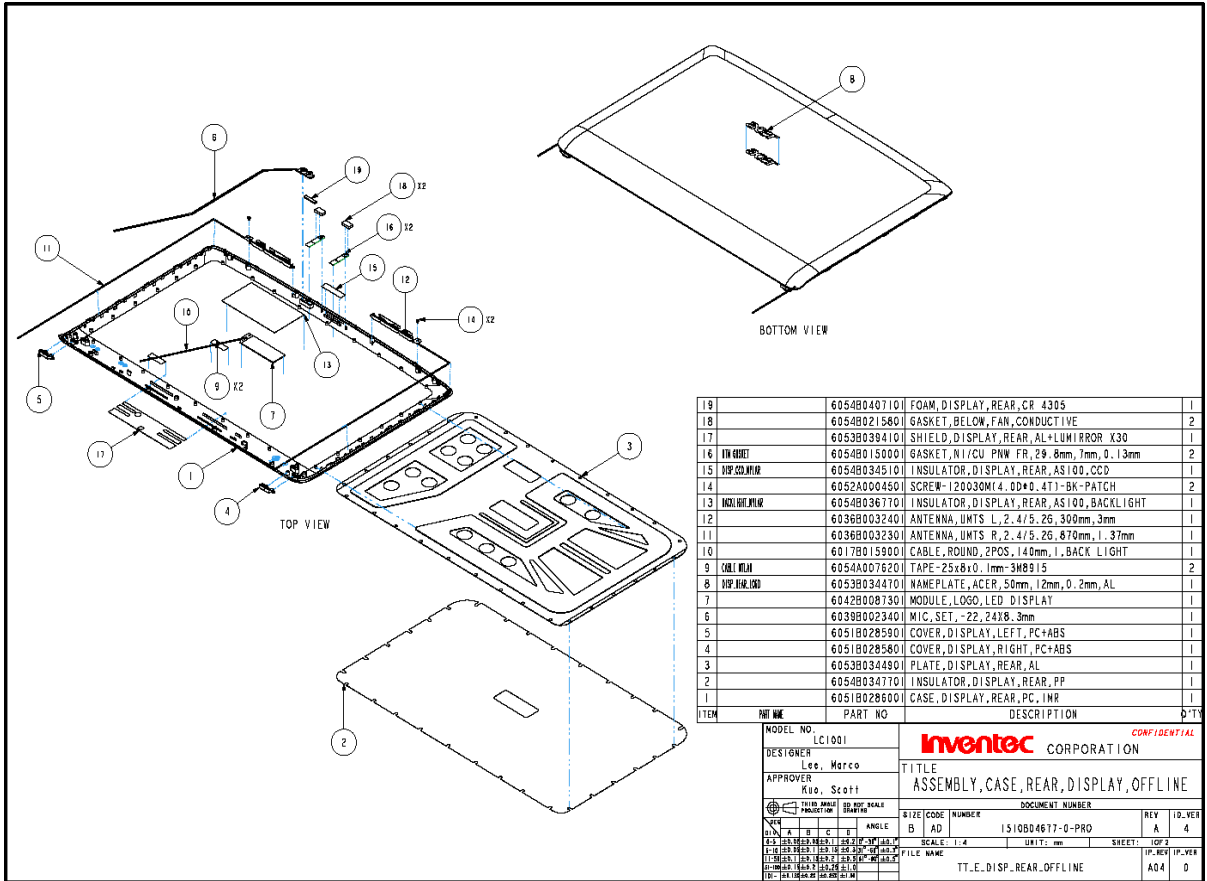

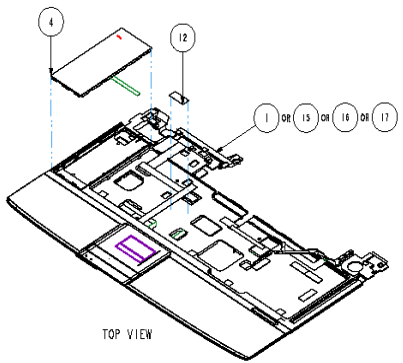
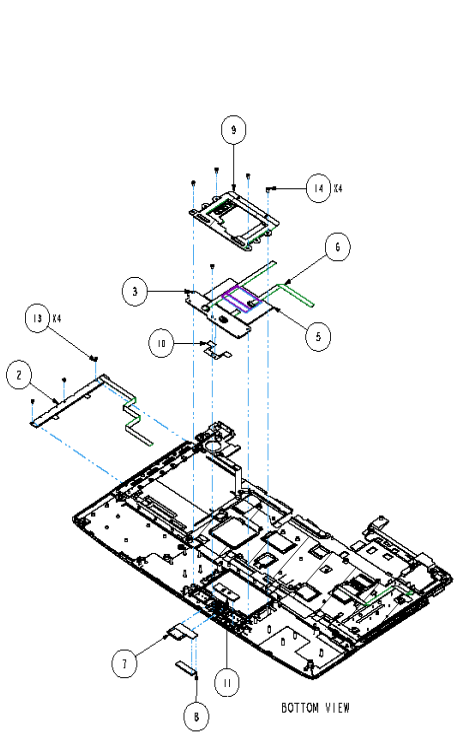

ITEM	QTY	PART NO	DESCRIPTION	01	02	03	04
17		1510B0467004	ASSEMBLY, CASE, TOP, OFFLINE				1
16		1510B0467003	ASSEMBLY, CASE, TOP, OFFLINE				1
15		1510B0467002	ASSEMBLY, CASE, TOP, OFFLINE		1		
14		6052A000980	SCREW, I_M2, S48, 4.5, 4, 0mm, MACH, 4, 5mm, 1, 0mm, CROSS, BN1, PATCH	4	4	4	4
13		6052A000450	SCREW-12000M4, 0040, 4T1-BK-PATCH	4	4	4	4
12		6060A008650	LABEL, BLANK-950-25x11	1	1	1	1
11		6054B040580	FOAM, CHARGE LENS, ML24	1	1	1	1
10		6054B039680	GASKET, FINGER, N17CU PPW FR	1	1	1	1
9		6053B034770	BRACKET, TOP, TOUCH PAD, SECC	1	1	1	1
8		6054B036730	FOAM, MOAB, 30, 0mm, 8, 0mm, 1, 3mm	1	1	1	1
7		6042B008600	MODULE, FINGER PRINTER	1	1	1	1
6		6035B002480	FIG, I2F, IL, 7, 7X0, 25X0, 81, PET, S	1	1	1	1
5		6034B000660	TOUCH PAD, NO BUTTON, I2F, 78, 7X47, 7	1	1	1	1
4		1397B003380	ASSEMBLY, MODULE, MEDIA	1	1	1	1
3		1397B003400	ASSEMBLY, MODULE, TR BUTTON	1	1	1	1
2		1397B003330	ASSEMBLY, MODULE, HOTKEY	1	1	1	1
1		1510B0467001	ASSEMBLY, CASE, TOP, OFFLINE	1			

MODEL NO.	LC1001	Inventec CORPORATION <small>CONFIDENTIAL</small>											
DESIGNER	Chen, April	TITLE											
APPROVER	Kuo, Scott	ASSEMBLY, CASE, TOP											
<table border="1"> <tr> <th>REV</th> <th>DATE</th> <th>DESCRIPTION</th> <th>BY</th> <th>CHKD</th> </tr> <tr> <td> </td> <td> </td> <td> </td> <td> </td> <td> </td> </tr> </table>		REV	DATE	DESCRIPTION	BY	CHKD						DOCUMENT NUMBER	
REV	DATE	DESCRIPTION	BY	CHKD									
<table border="1"> <tr> <td>SIZE</td> <td>CODE</td> <td>NUMBER</td> <td>REV</td> <td>IP_VER</td> </tr> <tr> <td>B</td> <td>AD</td> <td>1510B04668-0-PRO</td> <td>A</td> <td>7</td> </tr> </table>		SIZE	CODE	NUMBER	REV	IP_VER	B	AD	1510B04668-0-PRO	A	7	SHEET: TOP	
SIZE	CODE	NUMBER	REV	IP_VER									
B	AD	1510B04668-0-PRO	A	7									
FILE NAME		UNIT: mm	SHEET: TOP										
TT_E_TOP		AP4	2										

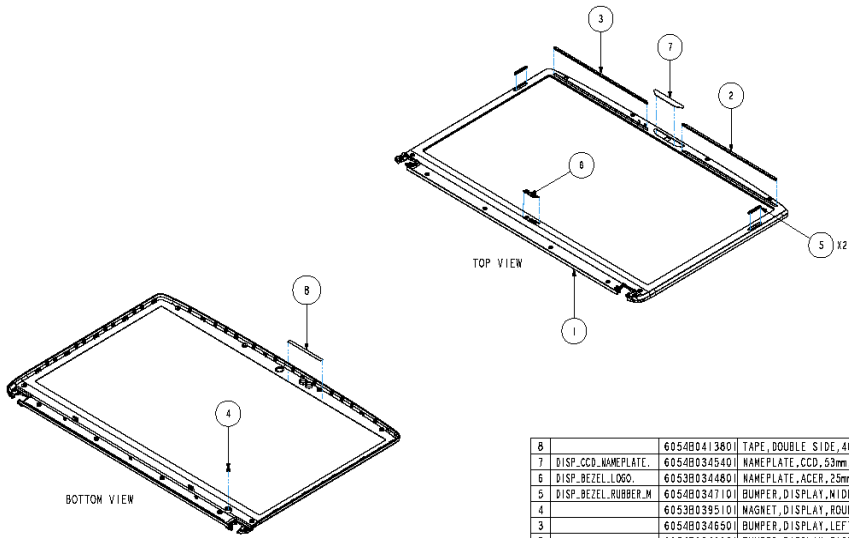

8	6054B041360	TAPE, DOUBLE SIDE, 40.0mm, 4.5mm, 0.15mm, 3M 988BT	1
7	DISP_CCD_NAMEPLATE. 6054B034540	NAMEPLATE, CCD, 52mm, 8.3mm, 0.55mm, PC	1
6	DISP_BEZEL_LOGO. 6053B034480	NAMEPLATE, ACER, 25mm, 6mm, 0.2mm, AL	1
5	DISP_BEZEL_RUBBER.M 6054B034710	BUMPER, DISPLAY, MIDDLE, SILICONE	2
4	6053B039510	MAGNET, DISPLAY, ROUND, 4.0mm, 2.0mm, NI	1
3	6054B034650	BUMPER, DISPLAY, LEFT, SILICONE	1
2	6054B034660	BUMPER, DISPLAY, RIGHT, SILICONE	1
1	6051B028610	CASE, DISPLAY, FRONT, PC+ABS	1

ITEM	PART NAME	PART NO	DESCRIPTION	P-TX	
MODEL NO.		LC1001	Inventec CORPORATION CONFIDENTIAL TITLE ASSEMBLY, BEZEL, DISPLAY, OFFLINE		
DESIGNER		Lee, Marco			
APPROVER		Kuo, Scott	DOCUMENT NUMBER		
THIRD PARTY PRODUCTION THIS DRAWING IS THE PROPERTY OF INVENTEC CORPORATION. IT IS TO BE USED ONLY FOR THE PROJECT AND FOR THE QUANTITY SPECIFIED. IT IS NOT TO BE REPRODUCED OR COPIED IN ANY MANNER WITHOUT THE WRITTEN PERMISSION OF INVENTEC CORPORATION.		SIZE CODE B AD	NUMBER 1510B4678-0-PRO	REV C	ID_VER D
		SCALE: 1:1	UNIT: mm	SHEET: 10F2	
		FILE NAME	TT_E_DISP_BEZEL_OFFLINE	IP_REV	IP_VER
				A03	D

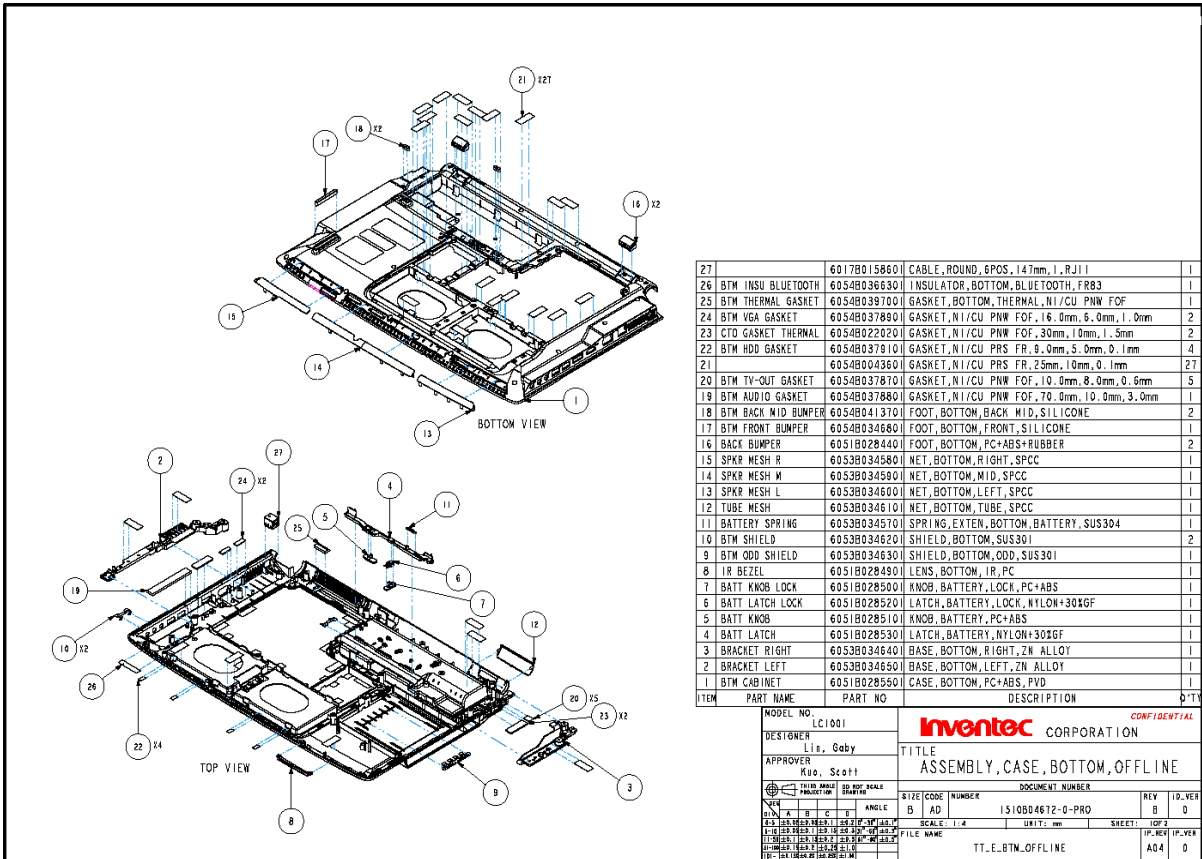

27	6017B015860	CABLE, ROUND, 6POS, 147mm, 1, RJ11	1
26	6054B036630	INSULATOR, BOTTOM, BLUETOOTH, FRB3	1
25	6054B038700	GASKET, BOTTOM, THERMAL, NI/VCU PNW FOF	1
24	6054B037890	GASKET, NI/VCU PNW FOF, 16.0mm, 6.0mm, 1.0mm	2
23	6054B022020	GASKET, NI/VCU PNW FOF, 30mm, 10mm, 1.5mm	2
22	6054B037910	GASKET, NI/VCU PRS FR, 9.0mm, 5.0mm, 0.1mm	4
21	6054B004360	GASKET, NI/VCU PRS FR, 2.5mm, 10mm, 0.1mm	27
20	6054B037870	GASKET, NI/VCU PNW FOF, 10.0mm, 8.0mm, 0.6mm	5
19	6054B037860	GASKET, NI/VCU PNW FOF, 70.0mm, 10.0mm, 3.0mm	1
18	6054B041370	FOOT, BOTTOM, BACK, MID, SILICONE	2
17	6054B034660	FOOT, BOTTOM, FRONT, SILICONE	1
16	6051B028440	FOOT, BOTTOM, PC+ABS+RUBBER	2
15	6053B034580	NET, BOTTOM, RIGHT, SPCC	1
14	6053B034590	NET, BOTTOM, MID, SPCC	1
13	6053B034600	NET, BOTTOM, LEFT, SPCC	1
12	6053B034610	NET, BOTTOM, TUBE, SPCC	1
11	6053B034570	SPRING, EXTEN, BOTTOM, BATTERY, SUS304	1
10	6053B034620	SHIELD, BOTTOM, SUS301	2
9	6053B034630	SHIELD, BOTTOM, ODD, SUS301	1
8	6051B028490	LENS, BOTTOM, IR, PC	1
7	6051B028500	KNOB, BATTERY, LOCK, PC+ABS	1
6	6051B028520	LATCH, BATTERY, LOCK, NYLON+30XGF	1
5	6051B028510	KNOB, BATTERY, PC+ABS	1
4	6051B028530	LATCH, BATTERY, NYLON+30XGF	1
3	6053B034640	BASE, BOTTOM, RIGHT, ZN ALLOY	1
2	6053B034650	BASE, BOTTOM, LEFT, ZN ALLOY	1
1	6051B028550	CASE, BOTTOM, PC+ABS, FVD	1

MODEL NO.	LC1001		CONFIDENTIAL		
DESIGNER	Li, Gaby		TITLE		
APPROVER	Kuo, Scott	ASSEMBLY, CASE, BOTTOM, OFFLINE			
		DOCUMENT NUMBER		REV	IQ_VER
SIZE	CODE	NUMBER	REV	B	D
B	AD	1510B04672-0-PRD			
SCALE: 1:4		UNIT: mm	SHEET: 10/13		
FILE NAME		TT..E.BTN_OFFLINE		IP_REV	IP_VER
				A04	0

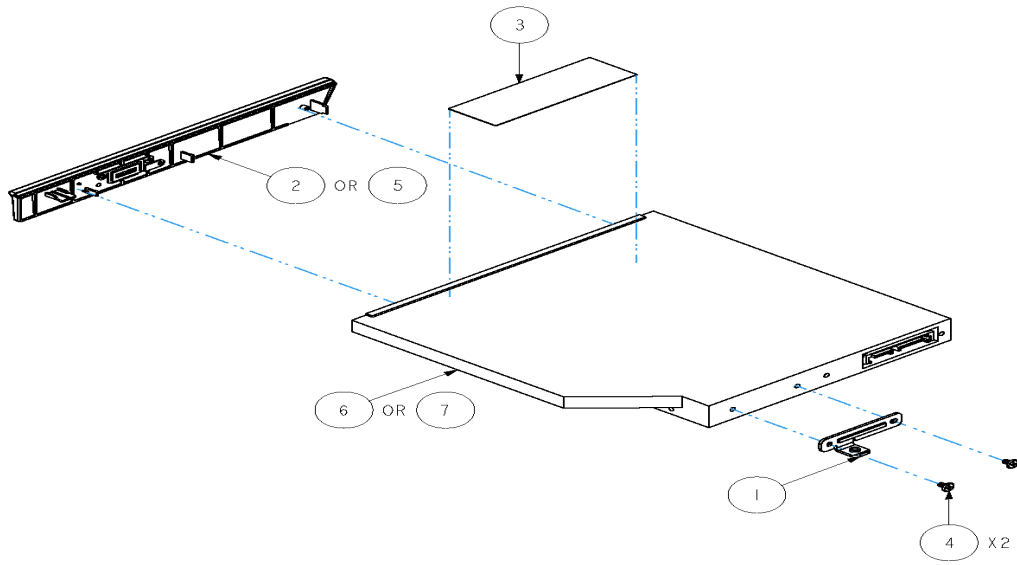











7		6029B002820	DVD, SUPER MULTI, SX, 8X, 8X, 8X, 8X, 24X, 24X, M2, 128X12, 7X126, 1mm, SLIM		1				
6		6029B002840	DVD, HD-COMBO, SX, 8X, 4X, 8X, 8X, 8X, 8X, 4X, 24X, M2, 128X12, 7X126, 1mm, SLIM		1				
5		1510B0468002	ASSEMBLY, BEZEL, ODD, OFFLINE		1				
4	SCREW 120030M4S8B10N1	6052B001250	SCREW, 1, M2, 0, 3, 0mm, M, 4, 5mm, 0, 8mm, B/N1, PATCH		2 2				
3		6060B022140	LABEL, BLANK, REEL, 60mm, 20mm		1 1				
2		1510B0468001	ASSEMBLY, BEZEL, ODD, OFFLINE		1				
1	CORON BRACKET	6053B003100	BRACKET, BOTOM, ODD, SECC		1 1				
ITEM				PART NAME	PART NO	DESCRIPTION		0	02





MODEL NO. LC1001		Inventec CORPORATION <i>CONFIDENTIAL</i>	
DESIGNER Lin, Gaby		TITLE ASSEMBLY, ODD	
APPROVER Kuo, Scott		DOCUMENT NUMBER	
		SIZE CODE	NUMBER
		A	AD
SCALE: 1:2		1510B04679-0-PRO	
UNIT: mm		REV	ID. VER
SHEET: 1 OF 1		B	1
FILE NAME		IP. REV	IP. VER
TT_E_ODD		A02	1

CATEGORY	PARTNAME	ACER PART NO.
ACCESSORY		
	REMOTE CONTROLLER FOMOSA21 RC804V-B EU	RT.22700.008
	REMOTE CONTROLLER FOMOSA21 RC804V-B TC	RT.22700.009
	REMOTE CONTROLLER FOMOSA21 RC804V-B SC	RT.22700.010
	REMOTE CONTROLLER FOMOSA21 RC804V-B EN	RT.22700.011
	EXTERNAL ANTENNA SET	25.AAMVN.004
	WISTRON ACER XPRESS CARD PHONE KIT REV 2.0	LC.VIP00.014
ADAPTER		
	ADAPTER 90W 3PINS DELTA ADP-90SB BBEA 1.7X5.5X11 LF LEVEL4	AP.09001.013
	ADAPTER 90W LITE-ON PA- 1900-24AR BLUE 1.7X5.5X11 LF LEVEL4	AP.09003.011
	ADAPTER 90W HIPRO HP- OL093B13P BLUE 1.7X5.5X11 LF LEVEL4	AP.0900A.001
BATTERY		
	BATTERY LI-ION 8CELL SANYO AS-2007B 4S2P 4800MAH	BT.00803.024
	BATTERY LI-ION 8CELL SONY AS-2007B 4S2P 4800MAH	BT.00804.020



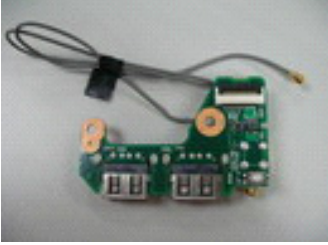

	BATTERY LI-ION 8CELL PANASONIC AS-2007B 4S2P 4800MAH	BT.00805.011
	BATTERY LI-ION 8CELL SIMPLO AS-2007B 4S2P 4800MAH	BT.00807.015
BOARD		
	WIRELESS LAN BOARD 802.11AGN INTEL 4965AGN MOW1 MINI PCI	KI.KDN01.001
	WIRELESS LAN BOARD 802.11AGN INTEL 4965AGN MOW2 MINI PCI	KI.KDN01.002
	WIRELESS LAN BOARD 802.11AGN INTEL 4965AGN ROW MINI PCI	KI.KDN01.003
	MINI WIRELESS BOARD 802.11ABG MOW1 INTEL MM872612	KI.GLN01.001
	MINI WIRELESS BOARD 802.11 ABG MOW2 INTEL MM872659	KI.GLN01.002
	MINI WIRELESS BOARD 802.11 ABG ROW INTEL MM874511	KI.GLN01.003
	MINI WIRELESS LAN BOARD 802.11BG INTEL 3945BG	KI.GLN01.005
	BLUETOOTH BOARD FOXCONN BCM2045 V2 T60H928.11	BT.21100.005
	MODEM BOARD MDC 1.5 FOXCONN T60M951.41 (AGERE 1.5_ 3.3V)	FX.22500.022



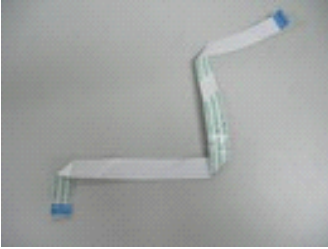
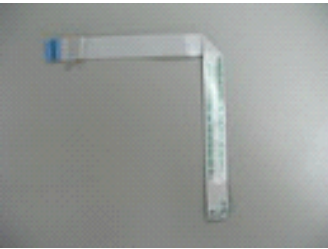

	<p>MODEM BOARD MDC 1.5 FOXCONN T60M951.36 (AGERE 1.5_ 3.3V) AUSTRALIA APPROVED</p>	<p>FX.22500.023</p>
	<p>TOUCHPAD SYNAPTICS TM-00372-012</p>	<p>56.APQ0N.001</p>
	<p>POWER BUTTON BOARD</p>	<p>55.AP50N.002</p>
	<p>MAINBOARD AS8920G INTEL PM965 ICH6M ATHEROS AR8121 LF</p>	<p>MB.AP50B.001</p>
	<p>HOTKEY BOARD</p>	<p>55.AP50N.001</p>
	<p>TOUCHPAD BUTTON BOARD</p>	<p>55.AP50N.003</p>

	<p>I/O BOARD</p>	<p>55.AP50N.004</p>
	<p>USB BOARD W/O TV CABLE</p>	<p>55.AP50N.005</p>
	<p>LED BOARD RIGHT</p>	<p>55.AP50N.006</p>
	<p>LED BOARD LEFT</p>	<p>55.AP50N.007</p>
	<p>FINGER PRINT BOARD</p>	<p>55.APQ0N.001</p>
	<p>MEDIA BOARD MODULE</p>	<p>55.APQ0N.005</p>

	<p>USB BOARD WITH TV CABLE</p>	<p>55.AP30N.001</p>
	<p>TV TUNER MINI CARD AVERMEDIA DVB-T A309 REV 1.0</p>	<p>TU.23100.014</p>
	<p>TV TUNER MINI CARD LITEON DVB-T TT-1260DA REV D</p>	<p>TU.23100.015</p>
	<p>ROBSON BOARD 1GB INTEL NVCPEMWR001G1 LF</p>	<p>KI.1GB0N.002</p>
	<p>VGA MXM BOARD NVIDIA 8ESEH 512MB W/ HDCP</p>	<p>55.AP70N.001</p>
	<p>VGA CARD nVidia NB8P-GS DDRII 512MB 400MHz 32*16 MXM II W/ HDCP (IEC VBIOS)</p>	<p>55.AKE0N.004</p>
<p>CABLE</p>		

	POWER CORD 3PIN USA	27.AAMVN.001
	POWER CORD 3PIN EUR	27.AAMVN.002
	POWER CORD 3PIN SOUTH AFRICA	27.AAMVN.008
	POWER CORD 3PIN DENMARK	27.AAMVN.010
	POWER CORD ISRAEL	27.AAMVN.011
	POWER CORD 3PIN ITALIAN	27.AAMVN.009
	POWER CORD 3PIN UK	27.AAMVN.004
	POWER CORD 3PIN SWISS	27.AAMVN.006
	POWER CORD AUSTRALIA W/LABEL	27.AAMVN.003
	POWER CORD 3PIN CHINA	27.AAMVN.005
	POWER CORD SOUTH AFRICA (AIL)	27.AAMVN.007
	POWER CORD 3PIN USA	27.AAMVN.001
	HOTKEY BOARD CABLE	50.AP50N.001
	POWER BUTTON BOARD CABLE	50.AP50N.002

	<p>TOUCH BUTTON BOARD CABLE</p>	<p>50.AP50N.003</p>
	<p>MEDIA BOARD CABLE</p>	<p>50.AP50N.004</p>
	<p>USB BOARD CABLE</p>	<p>50.AP50N.005</p>
	<p>TOUCHPAD CABLE</p>	<p>50.AP50N.006</p>
	<p>DC-IN CABLE</p>	<p>50.AP50N.007</p>
	<p>BLUETOOTH BOARD CABLE</p>	<p>50.AP50N.008</p>

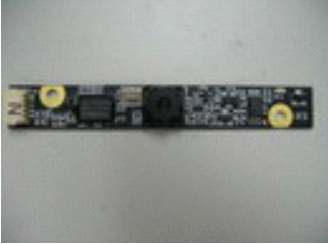
	<p>MODEM CABLE</p>	<p>50.AP50N.009</p>
	<p>MODEM CABLE WITH RJ11</p>	<p>50.AP50N.010</p>
	<p>FINGER PRINT BOARD CABLE</p>	<p>50.APQ0N.001</p>
	<p>"LCD/CAMERA CABLE 18.4" WUXGA/WXGA+"</p>	<p>50.AP50N.011</p>
	<p>"LCD/CAMERA CABLE 18.4" WUXGA/WXGA+"</p>	<p>50.AP50N.011</p>
	<p>"LCD/CAMERA CABLE 18.4" WXGA+"</p>	<p>50.AP50N.012</p>
<p>CAMERA</p>		
	<p>CAMERA 0.3M SUYIN</p>	<p>57.APQ0N.001</p>

	CAMERA 0.3M CHICONY	57.APQ0N.002
CASE/COVER/BRACKET ASSEMBLY		
	TOUCHPAD BRACKET	33.APQ0N.001
	UNILOAD COVER	42.AP50N.002
	MINI DUMMY CARD	42.AP50N.003
	SD DUMMY CARD	42.APQ0N.009
	LOWER CASE FOR TV	60.AP30N.001
	LOWER CASE	60.AP50N.001
	UPPER CASE W/ FINGER PRINT HOLE	60.AP50N.002
	MIDDLE COVER	42.AP50N.001

	<p>SUPER-MULTI BEZEL</p>	<p>42.APQ0N.004</p>
	<p>BD COMBO BEZEL</p>	<p>42.APQ0N.005</p>
	<p>OPTICAL BRACKET</p>	<p>33.AAMVN.002</p>
	<p>VGA BRACKET BOTTOM</p>	<p>33.AP70N.001</p>
	<p>VGA BRACKET TOP</p>	<p>33.APQ0N.003</p>
	<p>VGA BRACKET BOTTOM</p>	<p>33.AKE0N.005</p>
	<p>"LCD COVER 18.4" W/ ANTENNA & MIC"</p>	<p>60.AP50N.005</p>

	<p>"LCD BEZEL 18.4""</p>	<p>60.AP50N.004</p>
	<p>LCD BRACKET RIGHT</p>	<p>33.AP50N.001</p>
	<p>LCD BRACKET LEFT</p>	<p>33.AP50N.002</p>
	<p>HINGE COVER ASSEMBLY LEFT</p>	<p>42.APQ0N.007</p>
	<p>HINGE COVER ASSEMBLY RIGHT</p>	<p>42.APQ0N.006</p>

	KENSINGTON BRACKET	33.APQ0N.006
CPU/PROCESSOR		
	CPU INTEL CORE2DUAL T9500 PGA 2.6G 6M FSB800 PENRYN	KC.95001.DTP
	CPU INTEL CORE2DUAL T9300 PGA 2.5G 6M FSB800 PENRYN	KC.93001.DTP
	CPU INTEL CORE2DUAL T8300 PGA 2.4G 3M FSB800 PENRYN	KC.83001.DTP
	CPU INTEL CORE2DUAL T8100 PGA 2.1G 3M FSB800 PENRYN	KC.81001.DTP
	CPU INTEL CORE2DUAL T7800 PGA 2.6G 4M FSB800	KC.78001.DTP
	CPU INTEL CORE2DUAL T7700 PGA 2.4G 4M FSB800 G-0	KC.77G01.DTP
	CPU INTEL CORE2DUAL T7500 PGA 2.2G 4M FSB800 G-0	KC.75G01.DTP
	CPU INTEL CORE2DUAL T7300 PGA 2.0G 4M FSB800	KC.73001.DTP
	CPU INTEL CORE2DUAL T5750 PGA 2.0G 2M FSB667	KC.57501.DTP
	CPU INTEL CORE2DUAL T5550 PGA 1.83G 2M FSB667	KC.55501.DTP
	CPU INTEL CORE2DUAL T5450 PGA 1.66G 2M FSB667	KC.54501.DTP
DVD RW DRIVE		

	ASSEMBLY SUPLER MULTI MODULE 8X	6M.APQ0N.001
	DVD-RW DRIVE 8X SUPER- MULTI TRAY PIONEER DVR- KD08RS LF W/O BEZEL F/ W:1.00 PATA	KU.00805.043
	DVD-RW DRIVE 8X SUPER- MULTI TRAY PANASONIC TRAY UJ-870BAA-A LF W/O BEZEL F/W:1.00 PATA	KU.00807.058
	DVD-RW DRIVE 8X SUPER- MULTI TRAY PHILIPS DS- 8A1P LF W/O BEZEL F/ W:CA14 PATA	KU.00809.011
	DVD-RW DRIVE 8X SUPER- MULTI TRAY SONY AD- 7560A LF W/O BEZEL PATA	KU.0080E.005
	ASSEMBLY BD COMBO MODULE 2X	6M.APQ0N.002
	ODD BD COMBO DL 2X PANASONIC UJ-120B LF W/ O BEZEL PATA	KO.00207.001
	ODD BD COMBO DL 2X SONY BC-5500A LF W/O BEZEL 1.B1 PATA	KO.0020E.001
FAN		
	FAN	23.AP50N.001
HDD/HARD DISK DRIVER		

	HDD 120GB SATA 5400RPM SEAGATE ST9120817AS CORSAIR LF F/W:3.AAA	KH.12001.032
	HDD 120GB 5400RPM SATA TOSHIBA MK1246GSX LEO BS I LF F/W:LB213J	KH.12004.007
	HDD 120GB 5400RPM SATA II HGST HTS542512K9SA00 BRONCO-B LF F/W:C31P	KH.12007.014
	HDD 120GB 5400RPM SATA WD WD1200BEVS-22UST0 ML125 LF F/W:01.01A01	KH.12008.019
	HDD 160GB 5400RPM SATA SEAGATE ST9160827AS CORSAIR LF F/W:3.AAA	KH.16001.029
	HDD 160GB 5400RPM SATA TOSHIBA MK1646GSX LEO BS LF F/W:LB113J	KH.16004.002
	HDD 160GB 5400RPM SATA II HGST HTS542516K9SA00 BRONCO-B LF F/W:C31P	KH.16007.016
	HDD 160GB 5400RPM SATA WD WD1600BEVT-22ZCT0 ML160 LF F/W:11.01A11	KH.16008.022
	HDD 160GB 5400RPM SATA SEAGATE ST9250827AS CORSAIR LF F/W:3.AAA	KH.25001.011
	HDD 160GB 5400RPM SATA TOSHIBA MK2546GSX LEO BS LF F/W:LB013J	KH.25004.001
	HDD 250GB 5400RPM SATA II HGST HTS542525K9SA00 LF F/W:C31P	KH.25007.011
	HDD 250GB 5400RPM SATA WD WD2500BEVS-22UST0 ML125 LFF/W:01.01A01	KH.25008.018
	HDD 320GB 5400RPM SATA WD WD3200BEVT-22ZCT0 ML160 LF F/W:11.01A11	KH.32008.013
HEATSINK		

	VGA HEATSINK	60.AP70N.001
	VGA HEATSINK	60.AP50N.006
	VGA HEATSINK FINGER	33.APQ0N.002
	CPU HEATSINK	60.AP50N.003
	CPU HEATSINK FINGER	33.AP50N.003
INVERTER		

	INVERTER BOARD TDK-TBD489NR	19.AP50N.001
	INVERTER BOARD TDK-TBD489NR	19.AP50N.001
KEYBOARD		
	KEYBOARD 17_18KB-FV1 88KS BLACK US INTERNATIONAL (GLOSSY)	KB.INT00.297
	KEYBOARD 17_18KB-FV1 88KS BLACK US INTERNATIONAL HEBREW (GLOSSY)	KB.INT00.298
	KEYBOARD 17_18KB-FV1 89KS BLACK UK (GLOSSY)	KB.INT00.299
	KEYBOARD 17_18KB-FV1 89KS BLACK TURKISH (GLOSSY)	KB.INT00.300
	KEYBOARD 17_18KB-FV1 88KS BLACK THAILAND (GLOSSY)	KB.INT00.301
	KEYBOARD 17_18KB-FV1 89KS BLACK SWISS/G (GLOSSY)	KB.INT00.302
	KEYBOARD 17_18KB-FV1 89KS BLACK SWEDISH (GLOSSY)	KB.INT00.303
	KEYBOARD 17_18KB-FV1 89KS BLACK SPANISH (GLOSSY)	KB.INT00.304
	KEYBOARD 17_18KB-FV1 89KS BLACK SLOVAK (GLOSSY)	KB.INT00.305
	KEYBOARD 17_18KB-FV1 89KS BLACK SLO/CRO (GLOSSY)	KB.INT00.306
	KEYBOARD 17_18KB-FV1 88KS BLACK RUSSIAN (GLOSSY)	KB.INT00.307

	KEYBOARD 17_18KB-FV1 89KS BLACK PORTUGUESE (GLOSSY)	KB.INT00.308
	KEYBOARD 17_18KB-FV1 89KS BLACK POLISH (GLOSSY)	KB.INT00.309
	KEYBOARD 17_18KB-FV1 89KS BLACK NORWEGIAN (GLOSSY)	KB.INT00.310
	KEYBOARD 17_18KB-FV1 89KS BLACK LUXEMBOURGISH (GLOSSY)	KB.INT00.311
	KEYBOARD 17_18KB-FV1 88KS BLACK KOREAN (GLOSSY)	KB.INT00.312
	KEYBOARD 17_18KB-FV1 88KS BLACK JAPANESE (GLOSSY)	KB.INT00.313
	KEYBOARD 17_18KB-FV1 89KS BLACK ITALIAN (GLOSSY)	KB.INT00.314
	KEYBOARD 17_18KB-FV1 88KS BLACK ISRAEL (GLOSSY)	KB.INT00.315
	KEYBOARD 17_18KB-FV1 89KS BLACK IRISH (GLOSSY)	KB.INT00.316
	KEYBOARD 17_18KB-FV1 89KS BLACK HUNGARIAN (GLOSSY)	KB.INT00.317
	KEYBOARD 17_18KB-FV1 88KS BLACK GREEK (GLOSSY)	KB.INT00.318
	KEYBOARD 17_18KB-FV1 89KS BLACK GERMAN (GLOSSY)	KB.INT00.319
	KEYBOARD 17_18KB-FV1 89KS BLACK FRENCH (GLOSSY)	KB.INT00.320
	KEYBOARD 17_18KB-FV1 89KS BLACK FINNISH (GLOSSY)	KB.INT00.321
	KEYBOARD 17_18KB-FV1 89KS BLACK DUTCH (GLOSSY)	KB.INT00.322
	KEYBOARD 17_18KB-FV1 89KS BLACK DANISH (GLOSSY)	KB.INT00.323
	KEYBOARD 17_18KB-FV1 89KS BLACK CZECH (GLOSSY)	KB.INT00.324

	KEYBOARD 17_18KB-FV1 88KS BLACK TRADITIONAL CHINESE (GLOSSY)	KB.INT00.325
	KEYBOARD 17_18KB-FV1 89KS BLACK CANADIAN FRENCH (GLOSSY)	KB.INT00.326
	KEYBOARD 17_18KB-FV1 89KS BLACK BRAZILIAN PORTUGUESE (GLOSSY)	KB.INT00.327
	KEYBOARD 17_18KB-FV1 89KS BLACK BELGIUM (GLOSSY)	KB.INT00.328
	KEYBOARD 17_18KB-FV1 88KS BLACK ARABIC/ ENGLISH (GLOSSY)	KB.INT00.329
	KEYBOARD 17_18KB-FV1 89KS BLACK ARABIC/ FRENCH (GLOSSY)	KB.INT00.330
	KEYBOARD 17_18KB-FV1 89KS BLACK NORDIC (GLOSSY)	KB.INT00.331
	KEYBOARD 17_18KB-FV1 89KS BLACK ENGLISH/ CANADIAN FRENCH (GLOSSY)	KB.INT00.332
LCD		
	"LCD MODULE 18.4" WUXGA GLARE W/ ANTENNA & CCD 0.3M"	6M.AP50N.002
	"LCD 18.4" WUXGA SAMSUNG LNT184HT01- A01 GALRE LF 300NIT 8MS"	LK.18406.001
	"LCD MODULE 18.4" WXGA+ GLARE W/ ANTENNA & CCD 0.3M"	6M.AP50N.001
	"LCD 18.4" WXGA+ SAMSUNG LTN184KT01-A01 GLARE LF 220NIT 8MS 800:1"	LK.18406.002
MEMORY		

	<p>SODIMM 512MB DDRII667 NANYA NT512T64UH8B0FN- 3C LF</p>	<p>KN.51203.032</p>
	<p>SODIMM 512MB DDRII667 HYNIX HYMP164S64CP6-Y5 LF</p>	<p>KN.5120G.024</p>
	<p>SODIMM 512MB DDRII667 SAMSUNG M470T6464QZ3- CE6 LF</p>	<p>KN.5120B.026</p>
	<p>SODIMM 1GB DDRII667 NANYA NT1GT64U8HB0BN- 3C LF</p>	<p>KN.1GB03.014</p>
	<p>SODIMM 1GB DDRII667 HYNIX HYMP112S64CP6-Y5 LF</p>	<p>KN.1GB0G.012</p>
	<p>SODIMM 1GB DDRII667 SAMSUNG M470T2864QZ3- CE6 LF</p>	<p>KN.1GB0B.016</p>
	<p>SODIMM 2GB DDRII 667 HYNIX HYMP125S64CP8-Y5 LF</p>	<p>KN.2GB0G.004</p>
	<p>SODIMM 2GB DDRII 667 MICRON MT16HTF25664HY- 667E1 LF</p>	<p>KN.2GB04.001</p>
	<p>SODIMM DDRII 667 2GB SAMSUNG M470T5663QZ3- CE6 LF</p>	<p>KN.2GB0B.003</p>
<p>MISCELLANEOUS</p>		
	<p>HDD INSULATOR</p>	<p>42.AAMVN.005</p>
	<p>VGA BOARD INSULATOR</p>	<p>47.AKE0N.002</p>

	<p>LCD CHUSION</p>	<p>47.APQ0N.001</p>
<p>SCREW</p>		
	<p>SCREW I M2 6MM M 4.5MM 0.8MM PHIL BK PATCH</p>	<p>86.APQ0N.004</p>
	<p>SCREW M2.5X0.45</p>	<p>86.APQ0N.001</p>
	<p>SCREW I M2.5 3MM M 4.5MM 0.8MM NI PATCH</p>	<p>86.AP50N.001</p>
	<p>SCREW BNI PAT</p>	<p>86.TLT0N.002</p>
	<p>SCREW PAN M2*0.4 6.0MM MACH 3.0MM 0.7MM CROSS NI</p>	<p>86.AP50N.002</p>
	<p>SCREW</p>	<p>86.TCXVN.006</p>
	<p>SCREW</p>	<p>86.AAMVN.001</p>
<p>SPEAKER</p>		
	<p>SPEAKER SET W/ SUB- WOOFER</p>	<p>23.AP50N.002</p>
	<p>Speaker Set (Front)</p>	<p>23.AP50N.003</p>